



P R O D U C T C A T A L O G

**WILCOX<sup>®</sup>**

# OUR MISSION

## SUPPORTING THE ELITE WARFIGHTER

From the very beginning, Wilcox has built a trusted reputation by dedicating and demonstrating commitment to you, our customers. Innovative by culture, critically focused on quality, every feature of our products is designed with you in mind. Constant communication, collaboration and direct interaction with you is what informs and drives every aspect of our Wilcox “systems of systems” approach to Warfighter capability development.

As a proud ISO 9001:2015 certified company, our standards for quality are demonstrated every single day throughout the entire process from design, testing and verification, production, product launch and subsequent service support. No matter what the product material, size or complexity, the Wilcox commitment to quality and customer support never ends. The Wilcox brand remains synonymous for cutting-edge innovation and unsurpassed quality, while at the same time increasing the operational capability and providing a tactical discriminator that is simply without peer.

In 1993, we were awarded our first patent with the development of the first laser aiming device integrated into a handgun. In 1996, Wilcox responded to a call from the Special Operations Community in search of a solution to effectively mount night vision systems. Working closely with the operators, the three-hole shroud was born and a “systems approach” to night vision device mounting solutions was formally initiated. This continues today with our next generation Enhanced Night Vision Goggle (ENVG) and other mounting solutions. To date, Wilcox has been awarded over 80 patents with 69 more pending. Wilcox has evolved into an agile, highly diversified global company offering over 260 products with a customer base in 28 countries worldwide.

Vertically enabled operations are implemented within our modern, 220,000 square foot engineering and manufacturing facility in Newington, New Hampshire, USA. With our state-of-the-art design tools, advanced prototyping and fabricating test equipment, we can provide our customers with an unmatched responsiveness and quality without compromise. From a one piece helmet mount to a complex optic and integrated fire control system. No single part is addressed in isolation but is optimally designed and manufactured with both balance and focus on its inter-relationship to the overall role it plays in our “warfighter as a system” approach.

Whether operating in a remote distributed battle space, or within a dense urban environment, the diverse needs of you, our customers, drives us to deliver the highest level of quality possible and motivates us to develop new, innovative products. Products designed to enhance operations and survivability, increase situational awareness, generate greater tempo and provide maximum lethality at the tactical edge.



**JAMES W. TEETZEL**  
CHAIRMAN & CEO



















***“Our Customer’s Life Depends On It”™***



SEE INSIDE WILCOX











# PRODUCT ICONS

 INFRARED LASER	 123A BATTERY(S)
 VISIBLE LASER	 AA BATTERY(S)
 VARIABLE ILLUMINATOR	 BALLISTIC SOLVER
 FIXED ILLUMINATOR	 BLUETOOTH®
 WHITE LIGHT	 REFLEX SIGHT
 INFRARED LIGHT	 INTEGRATED IRON SIGHT
 LASER RANGEFINDER	 TRAJECTORY SWITCH
 HORN INTERFACE	 BREAKAWAY MOUNT
 DOVETAIL INTERFACE	 FORCE TO OVERCOME
 ANVIS INTERFACE	 LOW BATTERY INDICATOR
 POWERED MOUNT	 XL EXTENDED LENGTH
 BTAC ENABLED	 FIXED MOUNT

# TABLE OF CONTENTS

<b>04</b>	<b>A SYSTEMS APPROACH</b>
<b>05 – 26</b>	<b>COMBAT SYSTEMS</b>
07 – 10	LASER AIMING DEVICES
11 – 16	FIRE CONTROL SYSTEMS
17 – 22	FUSION SYSTEMS
23 – 26	WEAPON SOLUTIONS
<b>27 – 28</b>	<b>OPERATIONAL SUSTAINMENT</b>
<b>29 – 30</b>	<b>BTAC</b>
<b>31 – 54</b>	<b>NIGHT VISION MOUNTING SYSTEMS</b>
35 – 43	MOUNT / SHROUD COMBINATIONS
44	DPAM MOUNT
45 – 46	AERONOX SYSTEM
47 – 48	SHROUDS
49 – 50	NVG BINO BRIDGE SYSTEMS
51 – 52	NVG SOFT HEAD HARNESS
53 – 54	NVG PARTS & ACCESSORIES
<b>55 – 67</b>	<b>LIFE SUPPORT SYSTEMS</b>
57 – 62	HYBRID PATRIOT 5510 SYSTEM
63 – 64	QUICK RESPONSE KIT
65 – 67	EXOTHERMIC TORCH KIT & ACCESSORIES
<b>68</b>	<b>WARRANTY/SC INFORMATION</b>

# COLOR OPTIONS

 BLACK (-B)	 LUSTERLESS BROWN (-LB)
 MARITIME GREY (MG)	 OLIVE DRAB GREEN (-G)
 GUNSHIP GREY (GG)	 FOLIAGE (-F)
 TAN (-T)	 ADF GREEN (-77)
 COYOTE (-C)	 WHITE (-W)
 MULTICAM (-MC)	

\*NOT ALL PRODUCTS ARE AVAILABLE IN EVERY COLOR, CERTAIN PRODUCTS MAY REQUIRE A MINIMUM QUANTITY FOR COLORS OTHER THAN BLACK.

# ITAR/EXPORT COMPLIANCE

SELECT PRODUCTS SHOWN HEREIN ARE SUBJECT TO EXPORT CONTROLS ISSUED BY THE U.S. DEPARTMENT OF COMMERCE OR THE U.S. DEPARTMENT OF STATE AND REQUIRE A VALID EXPORT LICENSE TO BE SHIPPED OUTSIDE OF THE UNITED STATES. EXPORT OR RE-EXPORT WITHOUT PRIOR AUTHORIZATION FROM THE U.S. GOVERNMENT IS STRICTLY PROHIBITED. PLEASE CONTACT OUR EXPORT COMPLIANCE DEPARTMENT FOR ADDITIONAL INFORMATION.



## A SYSTEMS APPROACH TO COMBAT OPERATIONS

Integrating our robust line of Wilcox electro-optic combat systems and hybrid life support systems with the real time network created and powered by our partner Blueforce Development, our combined resources bring highly scalable and dynamically integrated capabilities to operations.

The high tempo requirements of today's operations dictate an ability to collapse decision space at all levels. Our systems approach leverages advanced sensors and rapid routing of real time actionable information, all critically focused to reinforce situational awareness - from the Command level out to the tactical edge.

This Operational View illustrates and reinforces the systems approach as the warfighter equipped with the Wilcox Fusion System observes a potential enemy threat, and quickly moves to orient on the target. Advanced electro-optics and sensors within the Fusion System enable rapid target acquisition and via system and Bluetooth networked interface, send an immediate alert to the Blueforce Tactical (BTAC) Mobile Command Center vehicle noting activity in real time with exact location alignment and target parameters.

The mobile Command Center immediately redirects an airborne sector drone to verify the potential threat and employing system cueing and correlation software, rapidly assess the situation to escalate or deescalate the engagement response. The target images captured by both the drone camera and the Wilcox Fusion System (equipped with the CMOS camera system option accessed via Bluetooth) are transmitted within the BTAC network equipped with AI powered target classification and biometric identification software, providing a response back to the warfighter within 7 seconds. The BTAC Mobile Command Center confirms the target is hostile and directs the warfighter to engage the target immediately, and further alerts all operators within the networked force of the escalated threat in sector.

Wilcox stands committed to providing our Elite Professionals with the most advanced and capable combat and life support systems in the world.

[www.wilcoxind.com/approach](http://www.wilcoxind.com/approach)





# COMBAT SYSTEMS

Wilcox has a proud heritage of innovative thinking, well proven to provide state-of-the-art technological solutions to meet the needs of our servicemen and women. We are committed to offer you Combat Systems that enhance the use of a weapon, with every feature designed within our systems approach to combat operations, and focused to maximize value and increase warfighter lethality.

Our Combat Systems are compact and balanced within the system, maximizing fit, form and function. Our leading edge laser systems and superior aiming and fire controls are easy to use and built to withstand the most grueling weather and combat conditions. Our entire family of weapon mounts and grips are machined from aerospace grade metals to keep them light weight and hard anodized for durability and long life.

Today's combat operations dictate an ability to generate tempo at all levels. Our systems approach integrates our robust line of Wilcox electro-optic combat systems with the real time network created by Blueforce Development, the result links our highly advanced sensors with the rapid routing of real time actionable information, all critically focused to reinforce the warfighters situational awareness, collapse decision space and enhance operations.

[www.wilcoxind.com/CombatSystems](http://www.wilcoxind.com/CombatSystems)

LASER AIMING DEVICES  
FIRE CONTROL SYSTEMS  
FUSION SYSTEMS  
WEAPON SOLUTIONS  
COMBAT SOLUTIONS



WATCH THE  
RAID Xe DEEP DIVE



# RAID X<sub>e</sub>

## RUGGEDIZED AIMING/ILLUMINATION DEVICE - ENHANCED - HIGH POWER



### OVERVIEW

The RAID Xe™ (Enhanced Ruggedized Aiming/Illumination Device) is the culmination of years of operator feedback and leading-edge technical advancements. The result is a compact, ergonomic aiming and illumination device with a uniquely rich feature set that achieves the highest standard of optical performance.

Military and law enforcement including special forces, SWAT and security personnel, face an array of unique challenges in low or no light environments where quick target acquisition and identification are required. As a class 3B high power laser aiming device, The Wilcox RAID Xe represents a complete, robust solution for any operator requiring a high degree of awareness, flexibility and accuracy to ensure mission success. The RAID Xe LP (Low Power) is also available.

[www.wilcoxind.com/RAID-Xe](http://www.wilcoxind.com/RAID-Xe)

Available Colors:  -C  -B

PRODUCT DESCRIPTION	PART NUMBER
RAID Xe - HIGH POWER RED LASER	65300G14
RAID Xe - HIGH POWER GREEN LASER	65300G18
RAID Xe - LOW POWER RED LASER	65300G12



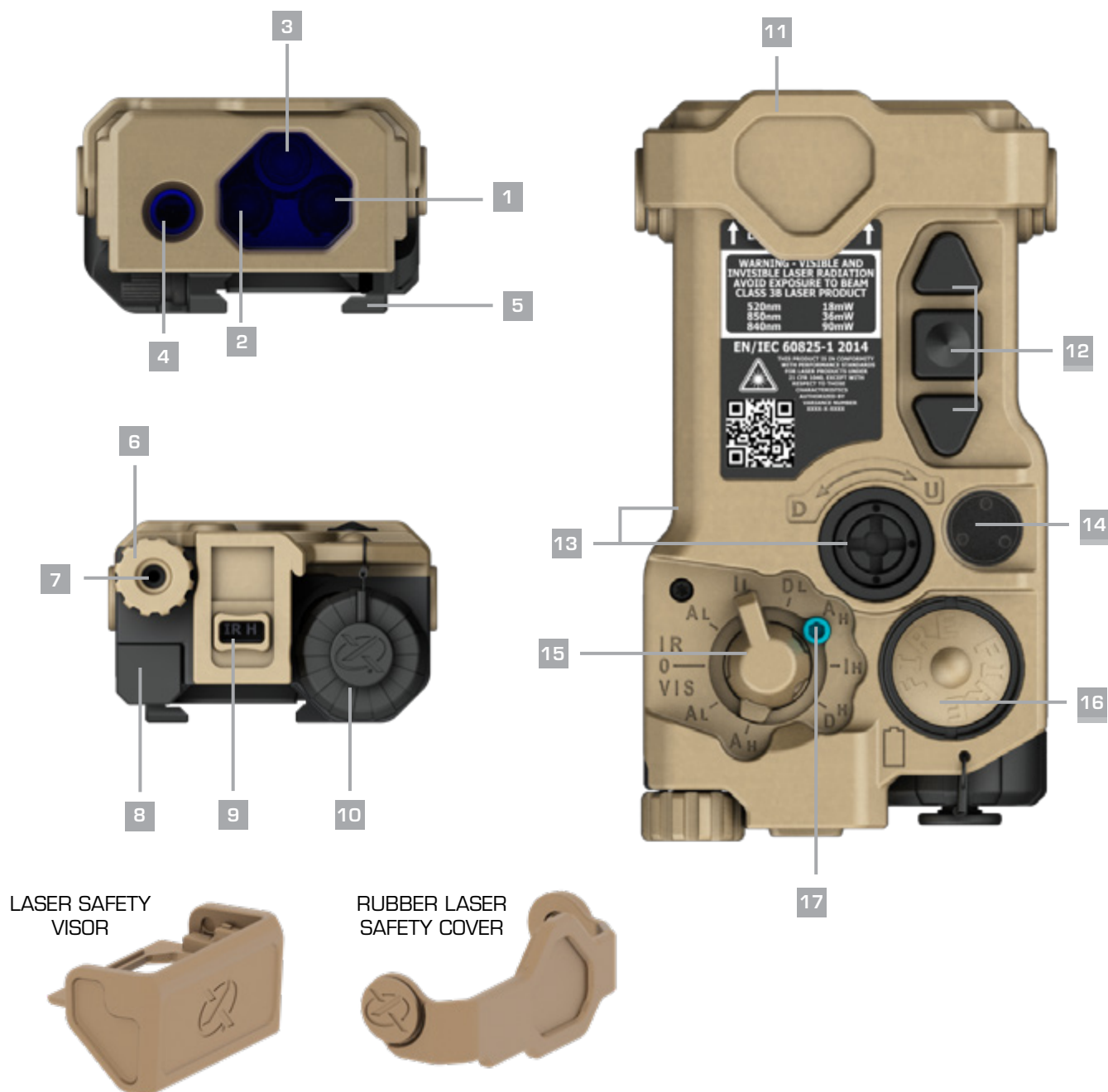

LASER SAFETY VISOR



RUBBER LASER SAFETY COVER



## FEATURES & BENEFITS

1. Red/Green VIS Laser
2. NIR Laser
3. NIR Variable Illuminator
4. NIR fixed Room Illuminator
5. MIL-STD-1913/NATO STANAG Interface
6. NIR Illuminator Divergence Knob
7. High Power Lockout Screw Storage
8. Remote/Pressure Pad Port
9. OLED Display
10. Battery Compartment
11. Laser Safety Cover
12. Laser/Illuminator Output Adjustment
13. Windage (not visible)/Elevation Adjustment
14. Display Light Sensor/Programming Port
15. Mode Selector Switch
16. FIRE Activation Button
17. High Power Lockout Screw



**BTAC**

**NETWORKED  
ENABLED CAPABILITY**

### SENSOR TO SHOOTER ADVANTAGE

- Providing actionable, task relevant information to and from networked teammates.
- Shot counter: Monitors shot count which is shared in real time with other users and the Armorer's Module for BlueforceCOMMAND.
- Temperature monitoring: Monitors weapon temperature and can forward based on high and low thresholds.
- Health/power: Monitors and reports maintenance flags or issues as part of the movement of shots, temperature, and location.
- Orthogonal sensor cueing allows the Wilcox BOSS Xe Plugin for BTAC to communicate with other BTAC plugins allowing image capture enabled sights to pass images to BTAC Cognitive Services Plugin for identification and real-time sharing.
- Offline queue: BTAC will hold presence packets when connectivity is denied. When BTAC sees an approved network, it forwards packets cached during offline operations.
- Network friendly Selective synchronization: Plugin may be configured to send ALL shot records, OR, only send those where shot count and/or temperature changes.

[Learn more about BTAC's unique capabilities.](#)

**BOSS Xe**<sup>TM</sup>

**BALLISTICALLY OPTIMIZED SIGHTING  
SYSTEM - ENHANCED - HIGH POWER**



### OVERVIEW

The BOSS Xe<sup>TM</sup> [Ballistically Optimized Sighting System – Enhanced] is a class 3B high power compact, ergonomic, laser aiming sighting system that is ideal for short barrel weapon platforms such as the SIG Rattler. The BOSS Xe has a unique optical bench that achieves the highest standard of performance while giving the operator tremendous flexibility.

Military and law enforcement including special forces and SWAT require connectivity, personalization, and varying degrees of visibility to overcome unique challenges in combat environments that require maximum discretion. The BOSS Xe's multi-function attributes are focused on providing operator's flexibility and customization to minimize engagement times, optimal target acquisition and engagement, and overall mission success. The BOSS Xe LP (Low Power) is also available

[www.wilcoxind.com/BOSS-Xe](http://www.wilcoxind.com/BOSS-Xe)

Available Colors: ■-B

PRODUCT DESCRIPTION	PART NUMBER
BOSS Xe - HIGH POWER RED LASER	64000G23
BOSS Xe - HIGH POWER GREEN LASER	64000G24
BOSS Xe - LOW POWER RED LASER	64000G22

IN PARTNERSHIP WITH:

**blueforce**  
DEVELOPMENT

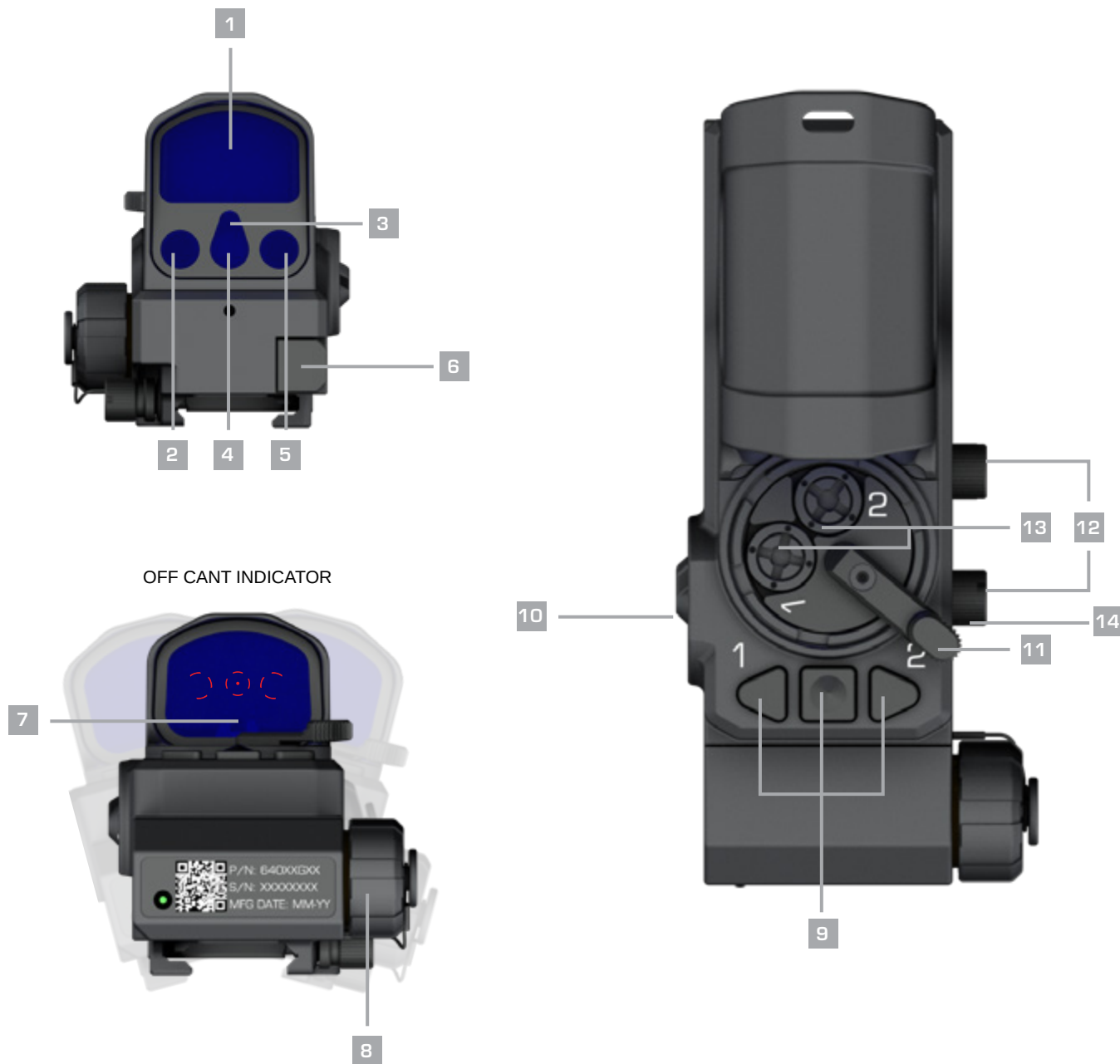

OFF CANT INDICATOR

## FEATURES & BENEFITS

1. Reflex Sight
2. NIR Laser
3. NIR room Illuminator
4. NIR fixed Illuminator
5. Red/Green VIS Laser
6. Remote Control Activation Pad Port
7. Built-in Back Up Iron Sights
8. Battery Compartment
9. Reflex/Laser/Illuminator Brightness Control
10. Mode Selector Switch
11. Trajectory Switch
12. Shock Nuts Picatinny Mount
13. Elevation Adjustment for Zero Presets 1 & 2
14. Windage Adjustment (not visible)



# RAPTAR X<sub>e</sub>

RAPID TARGETING & RANGING MODULE



## BTAC

### NETWORKED ENABLED CAPABILITY

#### SENSOR TO SHOOTER ADVANTAGE

- Providing actionable, task relevant information to and from networked teammates.
- Decentralized fusion and sharing of data from diverse sensors, processed with advanced third party AI
- Share target data on a need to know basis over tactical networks to other elements involved in an operation.
- Orthogonal sensor cueing allows the Wilcox RAPTAR Xe Plugin for BTAC to communicate with other BTAC plugins allowing image capture enabled sights to pass images to BTAC Cognitive Services Plugin for identification and real-time sharing.
- HyperLocal alerting capabilities can inform operators of relevant tactical information based on their location, competencies, and available resources.
- Connects shooters to sensors and artificial intelligence to assist operators in complex targeting scenarios that span acquisition and surveillance, identification, engagement, and handoff.

#### OVERVIEW

The Wilcox RAPTAR Xe™ is the next generation in the RAPTAR line of products. As a class 3B high power laser aiming device, the RAPTAR Xe is designed specifically for the military and law enforcement markets. The RAPTAR Xe provides snipers and advanced tactical shooters increased accuracy and precise engagement of targets at extremely long ranges. Compared to its predecessor, the RAPTAR Xe is a smaller, lighter, and stronger laser aiming device which significantly increases first-round hit capability. The built-in networking capabilities and user interface give the

RAPTAR Xe superior maintenance and replenishment connectivity with key auxiliary devices. These leading-edge features increase the operator's lethality and situational awareness.

[www.wilcoxind.com/RAPTAR-Xe](http://www.wilcoxind.com/RAPTAR-Xe)

Available Colors:  -C

PRODUCT DESCRIPTION	PART NUMBER
RAPTAR XE - HIGH POWER RED LASER	68500G01

IN PARTNERSHIP WITH:

**blueforce**  
DEVELOPMENT

APPLIED BALLISTICS   
THE SCIENCE OF ACCURACY

[Learn more about BTAC's unique capabilities.](#)

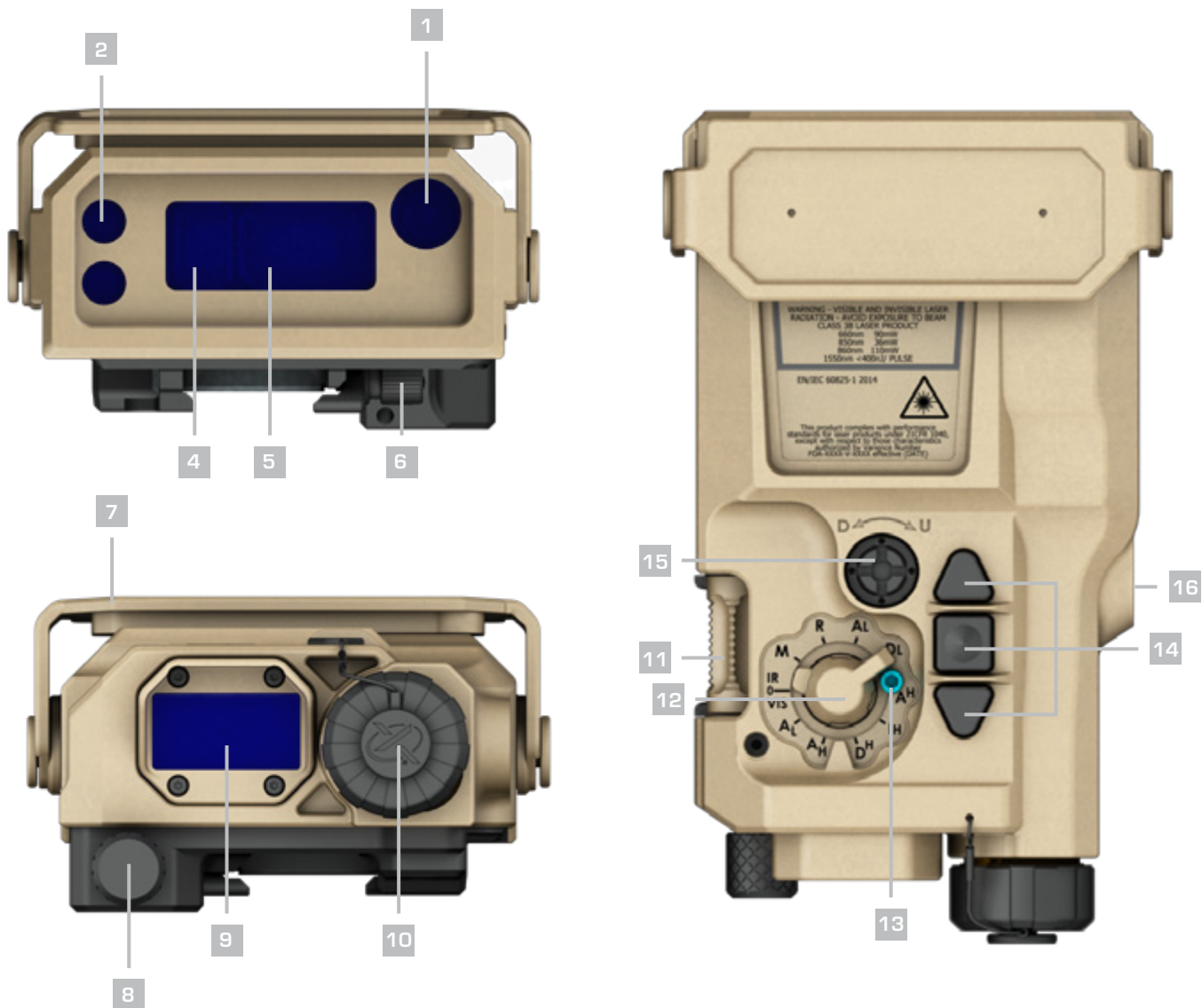

## FEATURES & BENEFITS

1. NIR Variable Illuminator
2. Red VIS laser
3. Infrared Laser
4. LRF/Laser Port
5. Range Receive Port
6. Shock Nuts Picatinny Mount
7. Laser Safety Hood
8. Remote Control Activation Pad Port
9. OLED Display
10. Battery Compartment
11. IR Flood Focus Wheel
12. Mode Selection Knob
13. High Power Lockout Screw
14. Fire/Input Buttons
15. Elevation Adjustment
16. Windage Adjustment



**BTAC**

**NETWORKED  
ENABLED CAPABILITY**

### SENSOR TO SHOOTER ADVANTAGE

- Providing actionable, task relevant information to and from networked teammates.
- Shot counter: Monitors shot count which is shared in real time with other users and the Armorer's Module for BlueforceCOMMAND.
- Temperature monitoring: Monitors weapon temperature and can forward based on high and low thresholds.
- Health/power: Monitors and reports maintenance flags or issues as part of the movement of shots, temperature and location.
- Orthogonal sensor cueing allows the Wilcox MRF Xe Plugin for BTAC to communicate with other BTAC plugins allowing image capture enabled sights to pass images to BTAC Cognitive Services Plugin for identification and real-time sharing.
- Network friendly Selective Synchronization: Plugin may be configured to send ALL shot records, OR, only send those where shot count and/or temperature changes.

[Learn more about BTAC's unique capabilities.](#)

**MRF X**

MICRO RANGE FINDER - ENHANCED  
LOW POWER



### OVERVIEW

The Wilcox MRF Xe™ is the next generation in the MRF line of products. As a class 3R low power laser aiming device, the MRF Xe is designed specifically for the military and law enforcement markets. The MRF Xe is a smaller, lighter, stronger laser ranging device with uncompromising performance superior to its predecessor. The built-in networking capabilities and user interface give the MRF Xe superior maintenance and replenishment connectivity with key auxiliary devices. These leading-edge features increase the warfighter's lethality and situational awareness.

Weapon and bullet information can be entered into the MRF Xe through any paired mobile device and with the application of proprietary third party software. Once the data is entered, the MRF Xe captures both the environmental conditions transmitted from the sensor suite and the distance to the target transmitted by the precision laser range finder to the onboard computer instantly providing a ballistic solution to the user.

[www.wilcoxind.com/MRF-Xe](http://www.wilcoxind.com/MRF-Xe)

Available Colors:  -C

PRODUCT DESCRIPTION	PART NUMBER
MRF Xe - LOW POWER RED LASER	42800G10

IN PARTNERSHIP WITH:



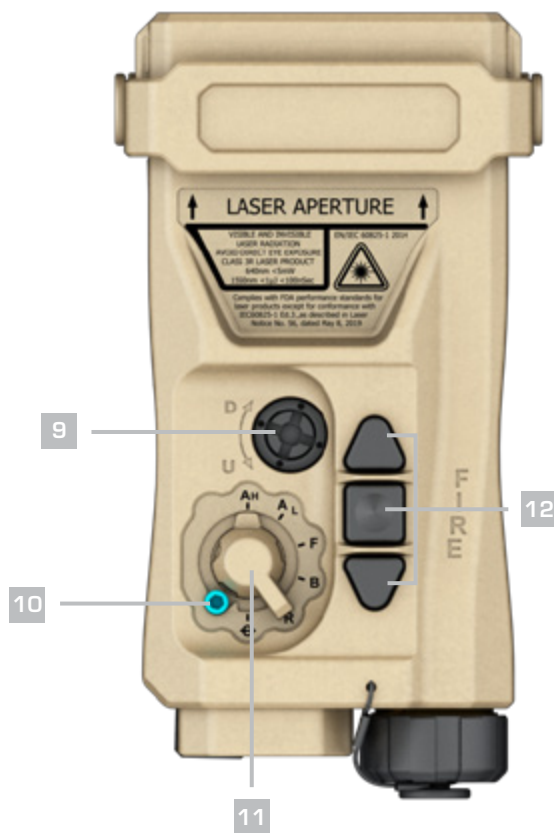
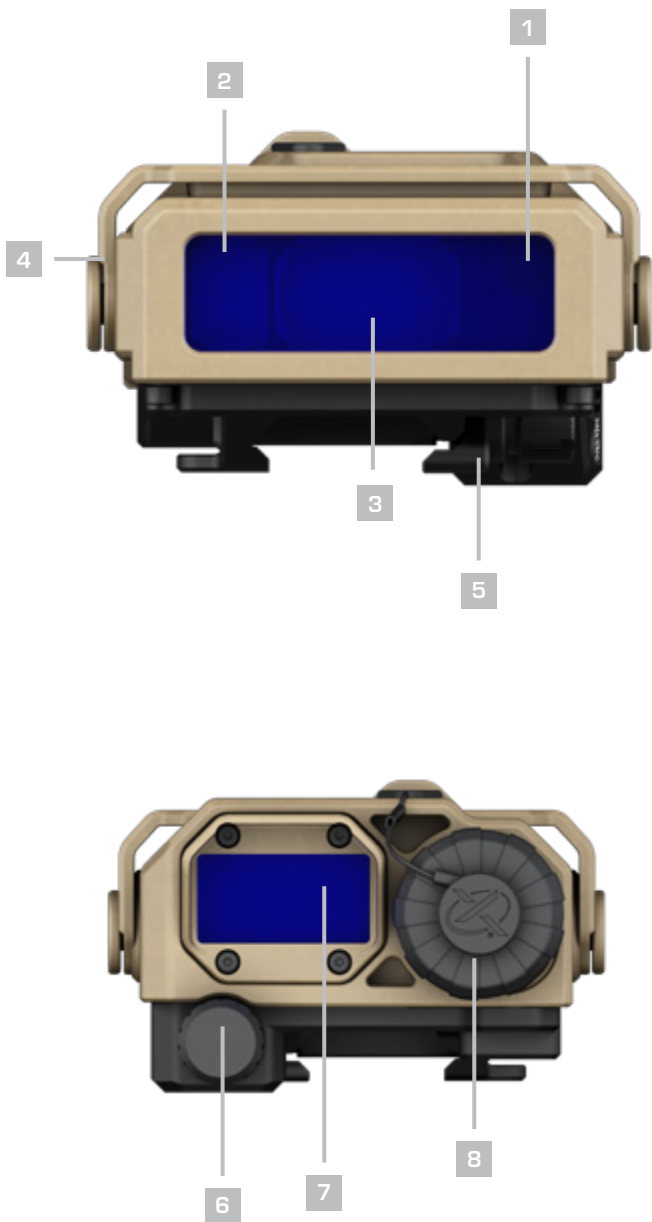

## FEATURES & BENEFITS

1. VIS Laser Pointer
2. LRF Transmitter
3. LRF Receiver
4. Laser Safety Visor
5. MIL-STD-1913 Interface
6. Remote Control Activation Pad Port
7. OLED Display/Ballistic Solver
8. Battery Compartment
9. Elevation Adjustment/Windage (not visible)
10. High Power Lockout Screw
11. Mode Selector Switch
12. Fire/Input Buttons



# GSS

## GRENADIER SIGHTING SYSTEM

US ARMY  
PROGRAM OF  
RECORD

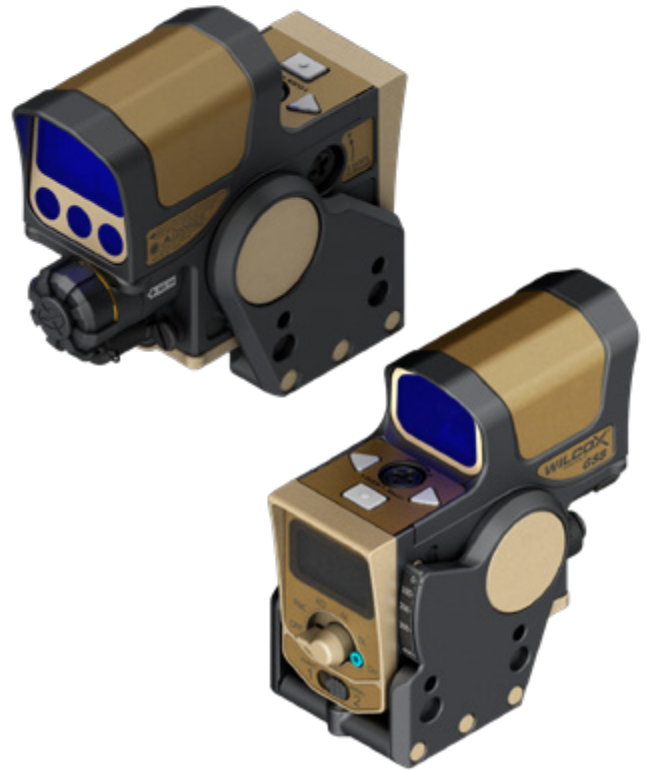

### OVERVIEW

The Wilcox GSS serves as a replacement for the previously fielded sight to the M320/M320A1 Grenade Launcher Module (GLM). The GSS addresses the capability gap within the forces to effectively engage targets, during day and at night, with the M320/M320A1 GLM. The GSS is designed for mounting on both the M4 carbine /M16 rifle forward rail when the M320 is in the under barrel configuration as well as on the top of the M320 GL when carried in a standalone configuration. The GSS produces dramatic increases in probability of hit both day and night engagements..

[www.wilcoxind.com/GSS](http://www.wilcoxind.com/GSS)

*Contact Wilcox directly for additional information.*

PRODUCT DESCRIPTION	NSN NUMBER
GRENADIER SIGHTING SYSTEM	1010-01-686-8798



# RAAM GSS™

RAPID ACQUISITION AIMING MODULE -  
GRENADE SIGHTING SYSTEM - HIGH POWER



## OVERVIEW

The Wilcox RAAM GSS™ is an exportable version of the US Army selected and current production Grenadier Sighting System (NSN: 1010-01-686-8798). It has proven to increase hit probability by significantly enhancing daytime and nighttime grenadier accuracy, while simultaneously decreasing target engagement time. With this unsurpassed performance, the ergonomic design incorporates many ease of use features. The RAAM GSS is designed for ambidextrous, left or right hand, mounting to any MIL-STD-1913 Picatinny side rail interface affixed to assault weapon (s) or a standalone man portable Grenade Launcher for simplicity and maintaining high accuracy, day and night.

[www.wilcoxind.com/RAAM-GSS](http://www.wilcoxind.com/RAAM-GSS)

Available Colors: ■-B

PRODUCT DESCRIPTION	PART NUMBER
RAAM GSS	67800G01



**BTAC**

## NETWORKED ENABLED CAPABILITY

### SENSOR TO SHOOTER ADVANTAGE

- Providing actionable, task relevant information to and from networked teammates.
- Shot counter: Monitors shot count which are shared in real time with other users and the Armorer's Module for BlueforceCOMMAND.
- Temperature monitoring: Monitors weapon temperature and can forward based on high and low thresholds.
- Health/power: Monitors and reports maintenance flags or issues as part of the movement of shots, temperature, and location.
- Sensor Fusion: FUSION plugin runs alongside of other BTAC plugins to include Wilcox RAPSTAR S, Wilcox HYBRID PATRIOT 5510, physiological, CBRN, subterranean trackers, signint, streaming body worn video, and other commercially available plugins.
- Offline queue: BTAC will hold presence packets when connectivity is denied. When BTAC sees an approved network, it forwards packets cached during offline operations.
- Network friendly selective synchronization: Plugin may be configured to send ALL shot records, OR, only send those where shot count and/or temperature changes.

[Learn more about BTAC's unique capabilities.](#)

# FUSION SYSTEM™

POWER MANAGEMENT, MAINTENANCE & INTEGRATED FIRE CONTROL SYSTEM™



## OVERVIEW

The Wilcox FUSION SYSTEM™ is a lightweight fully integrated fire control system that manages the power and maintenance of the rifle it is mounted to. A uniquely designed dual battery system features a primary and reserve battery compartment. The FUSION SYSTEM is a class 3B high power laser aiming device that features a fully integrated environmentally stable optical bench. An on-board sensor monitors the total count of rounds fired from the rifle like an odometer in a vehicle. This data connected through the depot's [BTAC Armorer's application](#) assures the users rifle is always maintained and ready for service. The FUSION SYSTEM differentiates itself from any other fire control system on the market by allowing an operator to fire different ammunition types from the same weapon by simply flipping a trajectory switch. Wilcox has set the standards for optical performance in beam clarity and uniformity aiding in increasing the warfighter's lethality and situational awareness.

Truly innovative, the FUSION SYSTEM has BTAC on board, further enabling a "smart weapon" design. The warfighter is able to connect the weapon via BTAC plugin to the network, providing awareness of the weapon's operational health while in the field as well as an armorer's interface for key predictive maintenance parameters associated with long term care. Learn more about [Operational Sustainment](#).

[www.wilcoxind.com/FUSION](http://www.wilcoxind.com/FUSION)



FUSION KMA556



FUSION ARX160



FUSION G62

Available Colors\*: -MC -W -C -B

PRODUCT DESCRIPTION	PART NUMBER
FUSION KMA556	65900G08
FUSION ARX160	65900G10
FUSION G62	65900G11
3X MAGNIFIER (SOLD SEPARATELY)	61100G16
STUBBY FUSION GRIP FOR KMA556 & G62 (SOLD SEPARATELY)	46208G01

\*Color options differ by weapon systems. (see datasheets for more information)

IN PARTNERSHIP WITH:



## FEATURES & BENEFITS

1. FUSION Reflex Sighting System
2. Red VIS Laser
3. NIR Fixed Illuminator
4. NIR Laser
5. Ballistic Trajectory Switch
6. Elevation/Windage Adjustment (Windage not visible)
7. Reflex/Laser/Illuminator Brightness Control
8. Built-in Back Up Iron Sights
9. OLED Display with Shot Counter
10. FUSION Mode Selector Switch
11. SureFire® White/NIR Dual Spectrum Light
12. Remote Light/Laser Activation Switch
13. Protective Grip Inserts for Heat Mitigation
14. Battery Management Power Supply System
15. 3X Magnifier and Flipmount (sold separately)
16. Stubby FUSION Grip (sold separately)



OPTIONAL STUBBY FUSION GRIP



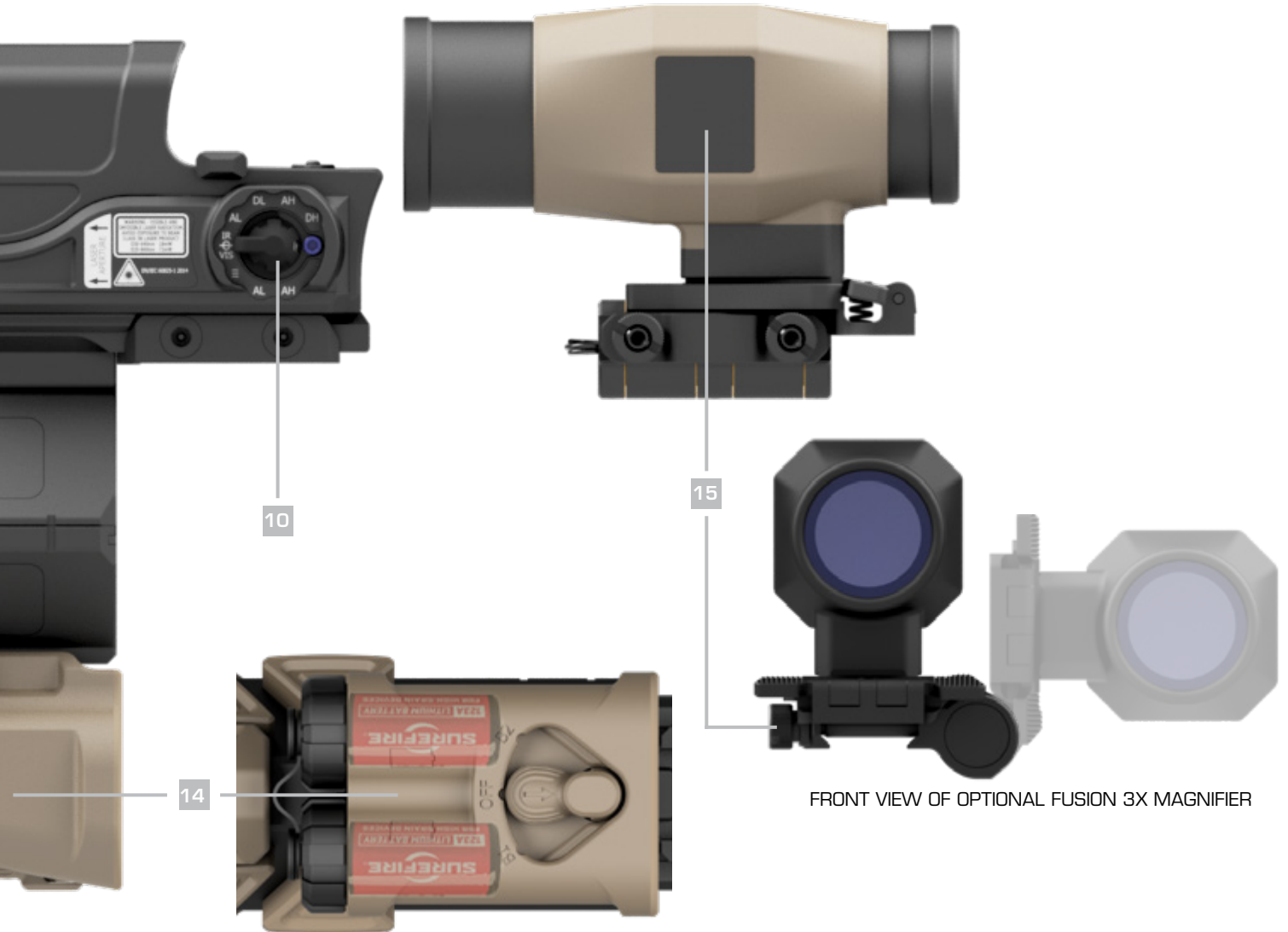

FRONT VIEW OF OPTIONAL FUSION 3X MAGNIFIER



# WILCOX ARMORER'S MODULE FOR BLUEFORCECOMMAND

## FULL ACCOUNTABILITY & MAINTENANCE MANAGEMENT

### OVERVIEW

The Armorer's Module is a managed database that stores weapon system serial numbers and allows the collection and management of maintenance performed based on usage. Specific data, (shots fired, time and date stamps, temperatures), is downloaded via Bluetooth from the FUSION weapon system to the database. This data can be used by the armorer to determine necessary maintenance including part replacement. The database can be queried for information including part usage, trends and inventory requirements. Other features include a list of part numbers and associated description including a thumbnail picture of the part. A picture of the replaced/worn/defective part can be attached to the associated system serial number for future reference. [Learn more about BTAC's unique capabilities.](#)



### FEATURES & BENEFITS

- Automatically accepts and processes shot record data from Wilcox FUSION Rail plugin for BlueforceTACTICAL Android.
- Access controls using the following roles: admin, assembly, and armorer user.
- Navigation and data entry support for bar code, QR code, and RFID readers.
- Rapid callup of weapons using hand entered and/or QR/RFID reader queries.
- Batch processing of RFID tracking data to identify last known location and weapon assignment.
- Robust maintenance management to include awareness of firearms that require maintenance and support for image attachments in maintenance records.
- Full logging of new firearm entry, firearm record updates, serial number changes, and firearm retirement.





# ERGOCTO® Xe™

## CONTROL ACTIVATION GRIP

### OVERVIEW

The Wilcox ERGOCTO™ Xe™ Control Activation Grip is the next generation accessory that is ergonomically positioned for the user to control Wilcox's new line of "Xe" laser and fire control devices. The ERGOCTO Xe Control Activation Grip mounts directly to the 6 o'clock rail position of the weapon with a unique grip design which allows for up to eight radial positions of the control button by the user. This feature provides an integrated control button that has an over molded skin featuring a tactile surface that helps prevent slippage of the weapon grip when controlling the device.

[www.wilcoxind.com/ERGOCTO-XE-GRIP-SINGLE](http://www.wilcoxind.com/ERGOCTO-XE-GRIP-SINGLE)

[www.wilcoxind.com/ERGOCTO-XE-GRIP-DUAL](http://www.wilcoxind.com/ERGOCTO-XE-GRIP-DUAL)

Available Colors:  -C  -B

DESCRIPTION	PART NUMBER
ERGOCTO Xe SINGLE CONTROL ACTIVATION GRIP - 7" CABLE	68401G11
ERGOCTO Xe DUAL CONTROL ACTIVATION GRIP - 7" CABLE	68401G12

# ERGOCTO® Xe™

## ACTIVATION KEYPAD

### OVERVIEW

The Wilcox ERGOCTO™ Xe™ Activation Keypad is the next generation accessory that is ergonomically positioned for the user to control Wilcox's new line of "Xe" lasers and fire control devices. The ERGOCTO Xe Activation Key Pad is mounted directly to any MIL-STD-1913 rail and can be positioned in-between the quadrant rails of most rifle handguards thereby preventing loss of the weapon grip when activating a device. The attachment mechanism of the ERGOCTO Xe Activation Key Pad features a very low-profile stance on the rail which does not interfere with the user's natural positioning of the pressure pad when handling a weapon. The ERGOCTO Xe Activation Key Pad is available in two configurations: single cable configuration that connects securely to Wilcox laser products (included with our Xe line of products) or a dual connector cable configuration that connects to the Wilcox Laser products and the other connects to any Surefire flashlight product that has the tail-cap interface.

[www.wilcoxind.com/ERGOCTO-XE-PAD-SINGLE](http://www.wilcoxind.com/ERGOCTO-XE-PAD-SINGLE)

[www.wilcoxind.com/ERGOCTO-XE-PAD-DUAL](http://www.wilcoxind.com/ERGOCTO-XE-PAD-DUAL)

Available Colors:  -B

DESCRIPTION	PART NUMBER
ERGOCTO Xe SINGLE 3 BUTTON ACTIVATION KEYPAD - 12" CABLE	68401G01
ERGOCTO Xe DUAL 3 BUTTON ACTIVATION KEYPAD - 12" CABLE	68401G03





Product Illustration   -C

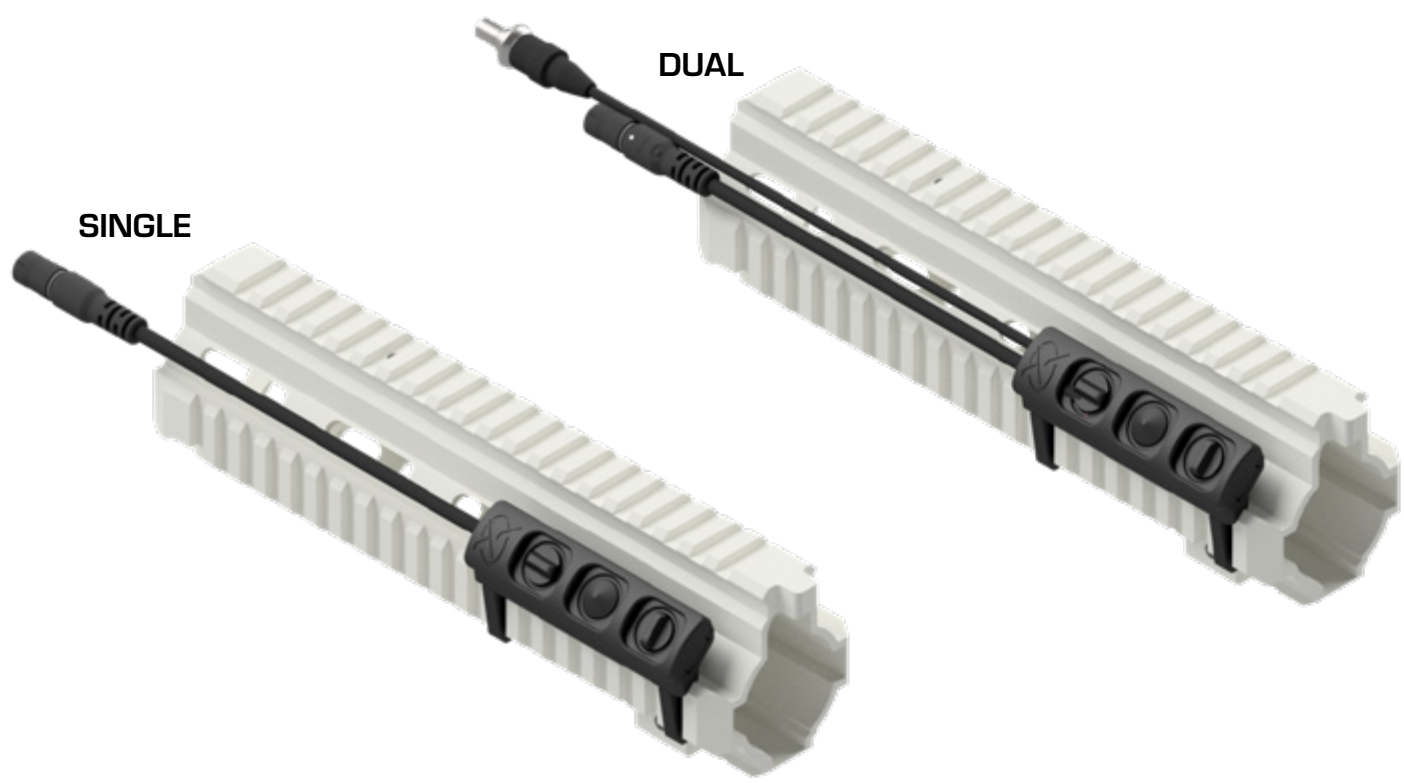

# 3X MAGNIFIER WITH FLIP MOUNT

## OVERVIEW

The Wilcox 3X magnifier is designed to work in conjunction with our family of FUSION Fire Controls Systems. The Wilcox Fusion Reflex Sight is designed to quickly acquire a target in close quarter battle when engagement speed is essential.

[www.wilcoxind.com/3X-Magnifier](http://www.wilcoxind.com/3X-Magnifier)

## SPECIFICATIONS

Sight Plane Height above the Rail 1.500"  
 Color: Black Matte Finish  
 Water Resistance: Waterproof to 1 Meter for up to 1 Hour

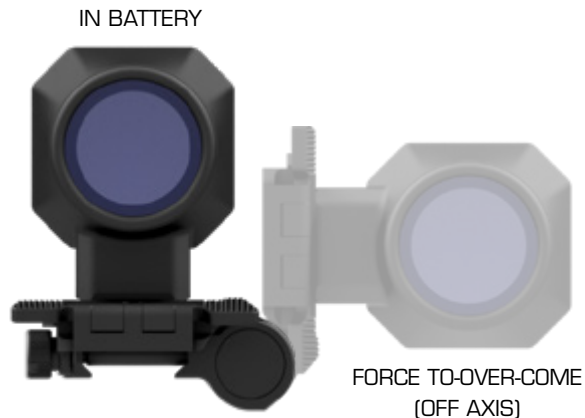

Available Colors:  -C  -B

DESCRIPTION	PART NUMBER
3X MAGNIFIER WITH FLIP MOUNT	61100G16

# EOTECH® MOUNT

## FLIP TO SIDE WEAPON MOUNT

## OVERVIEW

For use with EOTech 3X magnifiers. The flip mount attaches to 1913 style picatinny rails with two thumb nuts.

[www.wilcoxind.com/EOTECH-MOUNT](http://www.wilcoxind.com/EOTECH-MOUNT)

## SPECIFICATIONS

WEIGHT: 4.0 oz  
 DIMENSIONS: 2.5" L x 2.25" W x 1.0" H  
 FLIP DIRECTION: LEFT OR RIGHT AVAILABLE



Available Colors:  -B

DESCRIPTION	PART NUMBER
EOTECH MOUNT (RH)	61100G01
EOTECH MOUNT (LH)	61100G06

# SKEETIR®x / UTM® MOUNT

## FLIP TO SIDE WEAPON MOUNT

## OVERVIEW

The SkeetIR x/UTM flip mount allows mounting of a BAE thermal device. The flip mount attaches to 1913 style picatinny rails with two thumb nuts for easy attachment and removal without the use of tools, and features a lock release lever to actuate the flip mechanism.

[www.wilcoxind.com/SKEETIRX-MOUNT](http://www.wilcoxind.com/SKEETIRX-MOUNT)

## SPECIFICATIONS

WEIGHT: 3.4 oz  
 DIMENSIONS: 2.5" L x 2.25" W x 1.0" H  
 FLIP DIRECTION: LEFT ONLY



Available Colors:  -B

DESCRIPTION	PART NUMBER
SKEETIRx/UTM MOUNT (LH)	55900G03
SKEETIRx SHOE INTERFACE	55801G01
UTM SHOE INTERFACE	55901G01

# MINI N-SEAS MOUNT

## FLIP TO SIDE WEAPON MOUNT

### OVERVIEW

The Mini N-SEAS Flip Mount is modular allowing the operator to quickly transition their NVG from helmet to weapon. The flip mount attaches to 1913 style picatinny rails with two thumb nuts for easy attachment and removal without the use of tools.

### SPECIFICATIONS

WEIGHT: 4.8 oz  
 DIMENSIONS: 2.5" L x 2.25" W x 1.0" H  
 FLIP DIRECTION: LEFT OR RIGHT AVAILABLE



Available Colors: ■ -B

DESCRIPTION	PART NUMBER
MINI N-SEAS MOUNT (RH)	55900G04
MINI N-SEAS SHOE INTERFACE	55900G01

# SIG® JULIET 4 MOUNT

## FLIP TO SIDE WEAPON MOUNT

### OVERVIEW

The JULIET 4 Flip Mount provides rock solid mounting options for SIG® JULIET 4 4X magnifiers. Reliable like our field proven NVG mounts, the flip mount utilizes our standard dovetail shoe interface system for quick attachment or detachment of the magnifier without having to remove the flip mount from your weapon.

### SPECIFICATIONS

WEIGHT: 4.0 oz  
 DIMENSIONS: 2.5" L x 2.25" W x 1.0" H  
 FLIP DIRECTION: LEFT OR RIGHT AVAILABLE



Available Colors: ■ -B

DESCRIPTION	PART NUMBER
JULIET 4 FLIP MOUNT RH	61100G20
JULIET 4 FLIP MOUNT LH	61100G21

# AIMPOINT® MOUNT

## FLIP TO SIDE WEAPON MOUNT

### OVERVIEW

For use with Aimpoint 3X magnifiers. Utilizing our standard dovetail shoe interface system for quick attachment or detachment of the magnifier without having to remove the flip mount from the weapon.

[www.wilcoxind.com/AIMPOINT-MOUNT](http://www.wilcoxind.com/AIMPOINT-MOUNT)

### SPECIFICATIONS

WEIGHT: 4.8 oz  
 DIMENSIONS: 2.5" L x 2.25" W x 1.0" H  
 FLIP DIRECTION: LEFT OR RIGHT AVAILABLE



Available Colors: ■ -B

DESCRIPTION	PART NUMBER
AIMPOINT MOUNT (RH)	61100G14
AIMPOINT MOUNT (LH)	61100G15

# OPERATIONAL SUSTAINMENT

BY BLUEFORCE DEVELOPMENT

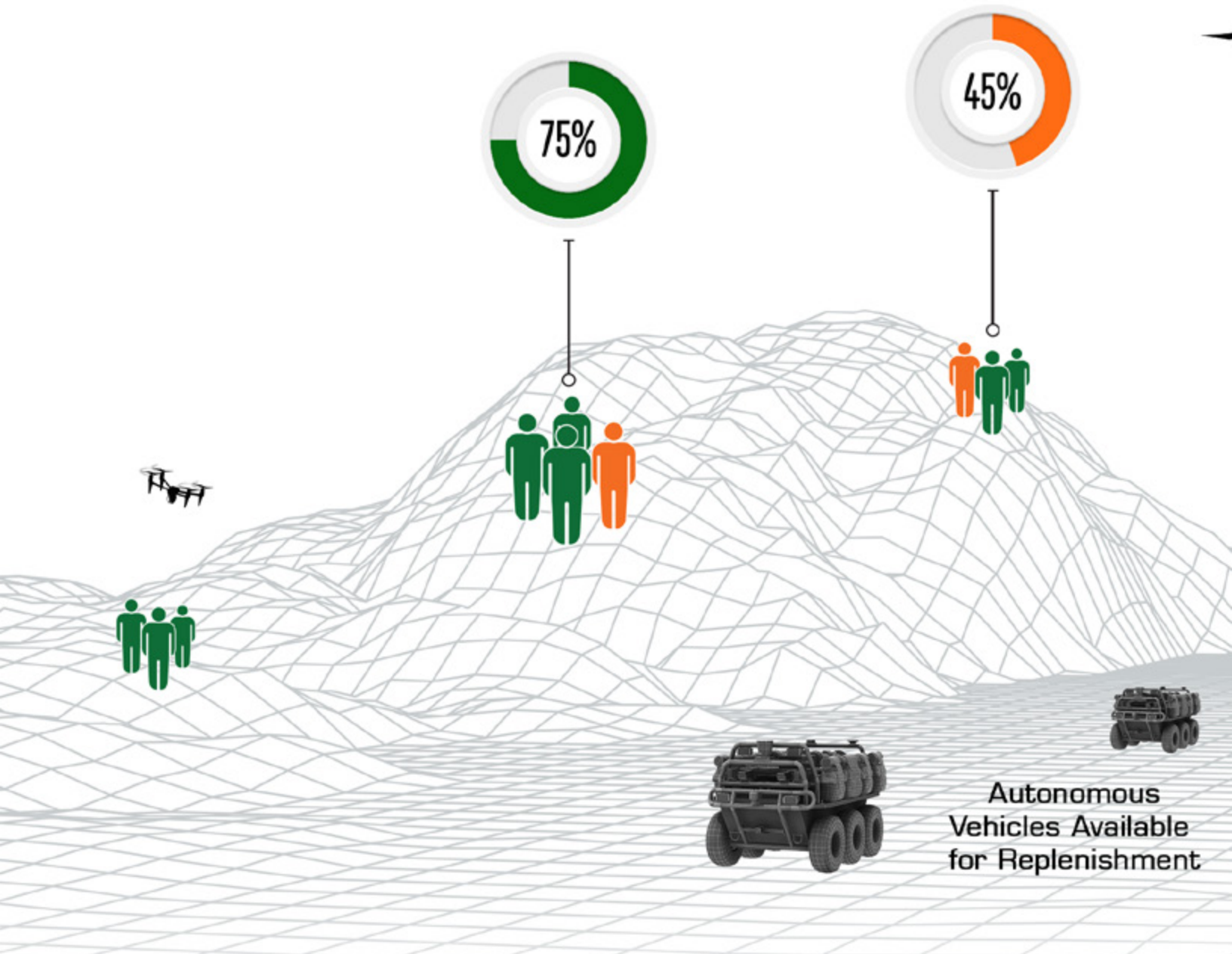

**Battlefield**, disaster response, and public safety sustainment is both an art and science; it's about synchronizing, integrating, and transporting commodities in a highly "just-in-time" manner to provide maneuver and incident commanders with freedom of action, extended operational reach, and prolonged endurance. As it turns out, the "**science**" of sustainment is not terribly difficult as it is grounded in basic math and computation, based on real-time data from the operational space. A fire team deploys with X amount of ammunition multiplied by the number of soldiers on a fire team, and then an ability to monitor ammunition consumption in real-time. The same calculus can be made for food, water, fuel, medical necessities, and nearly every other class of supply.

The "**art**" of sustainment is about considering how the tactical or incident response environment affects logistics and resupply. The "cog" at the center of the autonomous replenishment machine is data and situational awareness, fed by an array of IoT sensors (body worn and proximate) and stream analytics to anticipate resupply needs. Using a very simple example, a vehicle that takes X amount of petrol may be started early to warm up on a cold day which will require additional fuel sooner. Similarly, on a hot day with soldiers experiencing an accelerated operational tempo will drive faster and more acute need for resupply of water. Core to the discussion of "art", is all channel access to IoT, GIS, and environmental data, but also recognitional support "services" in the form of rules and AI.



Drone Replenishment In Route



Replenishment Needed

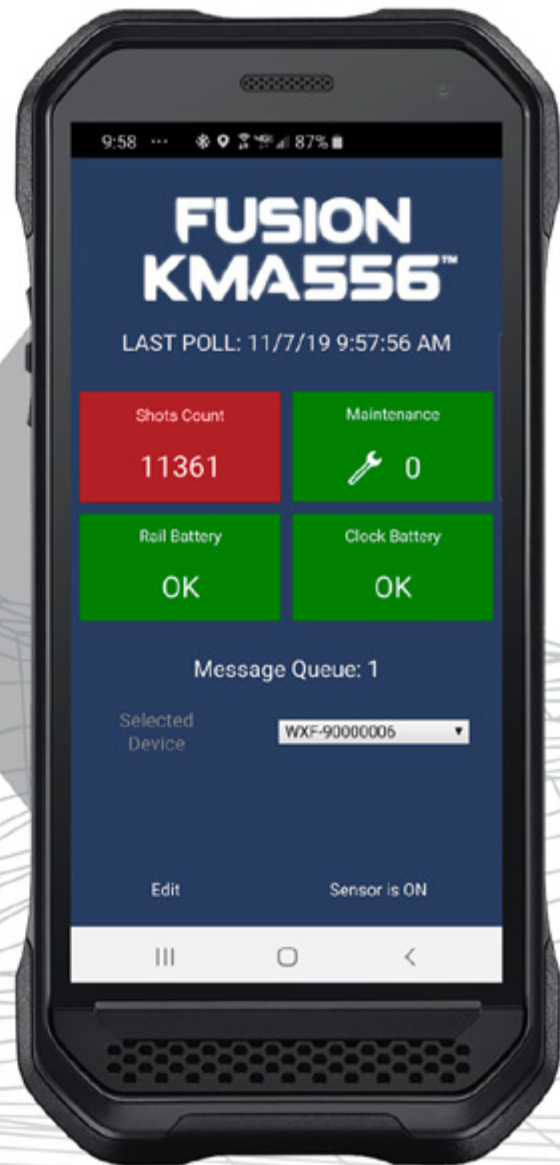

Wilcox Industries, has partnered with Blueforce Development Corporation and Thunderbolt Solutions to develop a packaged capability for operational sustainment based on deployed fire teams using the [Wilcox FUSION System](#) and the [Wilcox Xe Product Line](#). These products house an integrated maintenance counter which monitors the number of rounds fired as well as barrel temperature and other rail sensors and moves weapon data using [BlueforceTACTICAL](#) (BTAC) where the data is shared amongst the fire team and their commander but is also shared with the Wilcox Armorers Module in an armory. FUSION System data is also monitored in real-time by Blueforce's new Autonomous Orchestration Plugin for BlueforceEDGE, which monitors a wide array of soldier systems to include the Wilcox FUSION System,

physiological wearables, CBRN, laser rangefinders/targeting, and others for single-variant and multi-variant threats. The Plugin contains sets of business rules that can detect active engagement and shot counts, but also looks across an entire deployed fire team versus a single operator. On certain thresholds, the Plugin can launch autonomous drones, track vehicles, or other for resupply and/or over-watch.

[Learn more about BTAC's unique capabilities.](#)

IN PARTNERSHIP WITH:



SEE BTAC IN ACTION

DRONE



BTAC COMMAND CENTER



POTENTIAL THREAT

BTAC®



### PREDICTIVE MAINTENANCE

Wilcox weapons system data can be shared in real time with Wilcox Armorer's Module, a pluggable module for BlueforceCOMMAND, and the authoritative application for service and predictive maintenance.

### AUTONOMOUS REPLENISHMENT

Because BTAC and the Wilcox Plugin for BTAC are constantly monitoring weapons systems across a team, autonomous delivery platforms can be cued for just-in time field replenishment.

### FORCE READINESS

The Wilcox Armorer's Module not only drives supply chain value, but can also provide awareness of force readiness and can display weapon location and status.

### TACTICAL AWARENESS

Real-time shared awareness of oxygen and PPE operating modes, environmental data, maintenance counters, barrel temperature, and maintenance status of Wilcox devices shared in real-time amongst the team and command.

[Learn more about Operational Sustainment](#)

FUSION SYSTEM

FUSION SYSTEM™





NVG MOUNT  
COMPATIBILITY CHART



# NIGHT VISION MOUNTING SYSTEMS

Wilcox is the pioneer in the field of night vision mounting technology. We are proud to offer you full system solutions that are known for the quality, ruggedness and durability that will withstand the most grueling mission requirements. If you use a Wilcox shoe, shroud and NVG mount from our night vision mounting systems line, we guarantee a rock solid mounting system that virtually eliminates wobble. What sets Wilcox's NVG mounts above the rest includes features like a break away mechanism to minimize neck injury, aerospace grade metal with hard anodized coatings to maximize strength and several adjustment points to ensure a precise fit. We specialize in a holistic systems approach to what we offer and strive to set new industry standards in quality and workmanship, providing you the toughest, most effective tactical gear you need to do your job without compromise.

[www.wilcoxind.com/NVGMountingSystems](http://www.wilcoxind.com/NVGMountingSystems)

MOUNT / SHROUD COMBINATION

DPAM MOUNT

AERONOX SYSTEM

SHROUDS

NVG BINO BRIDGE SYSTEMS

NVG SOFT HEAD HARNESS

NVG PARTS AND ACCESSORIES



# AN ENGINEERED SYSTEM

## CONFIDENCE THROUGH QUALITY

Before Wilcox brings a product to market, we first ask, can we engineer and innovate a solution or improve a product that will have a profound impact on the soldier? What environmental conditions it can be subjected to? Lets take a look behind the scenes at our rigorous quality control testing.

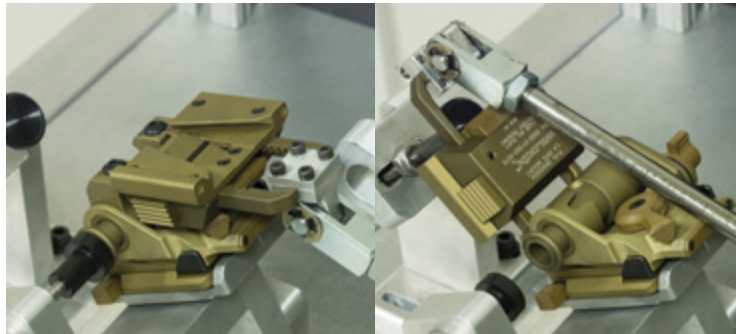
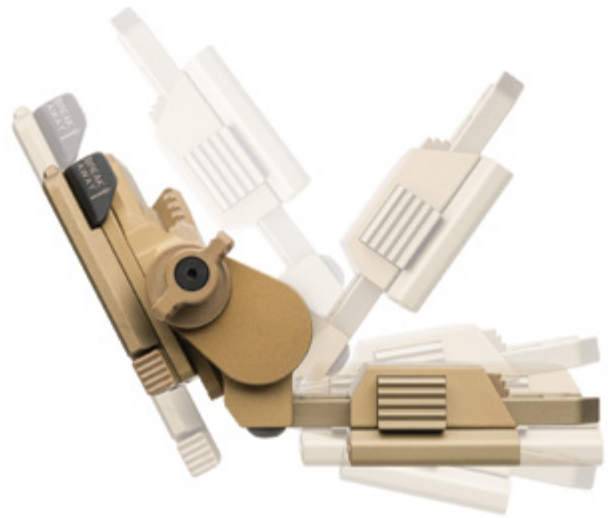

### LIFE CYCLE TESTING

We are proud of the science we have developed that goes into creating our mounts and the life cycle testing is no exception. Our cycle testing machine cycles our mounts to make sure they operate with unprecedented reliability. Each newly designed precision mechanism is cycled over 1 million times - that's quality and engineering you can count on.

### ENVIRONMENTAL TESTING

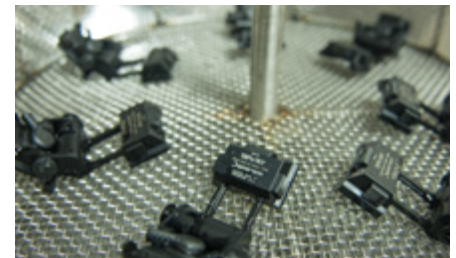

### SALT FOG CHAMBER

Do your missions require maritime operation? Our products endure rigorous salt fog testing to be sure our products stand up to the test of any extreme environmental exposure without risk of rusting or degrading its performance. Our qualification process takes place over the course of 96 hours in a salt fog tank - per MIL-STD-810. You know that when you buy a Wilcox product it will stand up to any environmental conditions.

### TEMPERATURE CHAMBER

If our product can stand up to the temperature chamber with temperatures ranging -94° F to 392° F (-70° C to plus 200° C), you can rest assured that even the most grueling mission requirements won't compromise the integrity or performance of our products. This kind of extreme temperature testing can detect failures before any product enters the field. With such rigorous testing, you can be sure a Wilcox product will work - every time.

### IMMERSION TANK

A combination of water and air pressure in our immersion pressure tank makes sure your Wilcox product can withstand the trials of a deep water mission environment. These tests simulate a diver at any given depth and pressure and pushes the limits of the air tight seal assemblies to guarantee no water or dust can invade the interior and compromise the product. We push our products to their limits to make sure that you can count on us in any conditions your mission requires.

# THE SCIENCE BEHIND THE SYSTEM



Adaptive vision allows us to own the night. Without sensors and a stable platform to hold a night vision goggle in place, adverse conditions can develop, often compromising the very reason for its existence. The defense industry is complex. As a soldier you have many choices of equipment to buy. By understanding how each component interacts with the other, you can make an informed decision buying the right equipment for your operational needs. Broken down by components, illustrating the importance of how one component needs the other, for the system to be stable and functional. One component does not work without the other. Need something? Call us or visit our website. We are here to help before, during and after the sale.

## HELMET

Helmets are made by a variety of manufacturers. The performance of a helmet is tightly regulated by the National Institute of Justice (NIJ). They are the evaluation agency for the US government to test the ballistic and impact characteristics of a productive helmet. For predictable performance, invest in an NIJ tested helmet.

## THE SKULL LOCK™

Without a secure fit of the helmet to the skull it would not support the weight and forces subjected to the helmet in adverse military operations. Any suspension and liner design that allows the soldier to quickly adjust for optimal comfort and customized fit is essential in order to maintain stability. Making the helmet one with your skull is key to the overall stability needs for the system and is often overlooked.

## THE SHROUD

The three hole shroud was invented by Wilcox. It was originally developed to accommodate all of the different types of helmets that existed in the 80's and 90's before the MICH program began in 2000. Bending the three ears of the

shroud offered a universal platform for mounting devices to a helmet. It was only natural that once the US Government defined a standard for outer shell geometry that a secure low profile snag free design would follow. Our line is the most cost effective solution in the market place today. It is the foundation of our system.

## THE MOUNT

There are seven moving precision mechanism features in every mount. The confidence we have in our manufacturing process allows us to consistently produce products that will exceed your expectation with virtually no excess movement.

## THE SHOE

The operations between the shoe and the mount's receiver is critical. The distinctive "click" that you hear, indicates that the shoe is firmly connected to the mount. Using shrouds and shoes made by other manufacturers will not assure the stability you would experience with our full system solutions.



# G24 MOUNT

## BREAKAWAY NIGHT VISION GOGGLE MOUNT



### OVERVIEW

The G24 low profile breakaway mount has become the night vision goggle industry standard. The G24 offers universal goggle mounting solutions for any night vision goggle with a dovetail shoe. During the G24's initial development, extensive operational input was considered and since its initial fielding, millions of operational hours have established operator muscle memory.

[www.wilcoxind.com/G24](http://www.wilcoxind.com/G24)

### FEATURES & BENEFITS

- Dovetail shoe interface securely locks NVG's into place
- Breakaway feature reduces the risk of neck injury
- Ergonomic adjustments allow for one handed operation
- Maintains a very low-profile on the helmet
- Developed & battle proven by U.S. & NATO SOF
- Backed by Wilcox's 5 year warranty

### SPECIFICATIONS

WEIGHT: 5.67 oz  
 DIMENSIONS: 3.98" L x 2.60" W x 2.40" H  
 FORE/AFT TRAVEL: 1.4"  
 HEIGHT ADJUSTMENT: .90"

Available Colors: ■ -B ■ -T

DESCRIPTION	NSN NUMBER	PART NUMBER
G24 MOUNT ONLY	-B 5855-01-593-6422	28300G24
	-T 5855-01-593-6375	



WATCH THE G24 DEMONSTRATION

# G24 MOUNT KITS

FULL SYSTEM SOLUTIONS



## G37 KIT

G24, ONE-HOLE SHROUD & LANYARD  
(MICH/ACH)



## G70 KIT

G24, THREE-HOLE SHROUD & LANYARD



## G41 KIT

G24, HYBRID SHROUD & LANYARD

Available Colors:  -B  -T

DESCRIPTION	NSN NUMBER	PART NUMBER
G24, ONE-HOLE SHROUD & LANYARD (MICH/ACH)		28300G37
G24, THREE-HOLE SHROUD & LANYARD	-B 5855-01-610-5116 -T 5855-01-610-9312	28300G70
G24, HYBRID SHROUD & LANYARD		28300G41



# G11 MOUNT

## NIGHT VISION GOGGLE MOUNT



### OVERVIEW

The G11 non-breakaway mount with horn interface shoe has become a night vision goggle industry standard. The G11, when attached to a Wilcox One-Hole HMI, Three-Hole HMI, or the standard Army shroud, allows firm attachment of the AN/PVS-7B/D and AN/PVS-14 when using Wilcox's AN/PVS-14 arm. The G11 maintains a very low profile stance on the helmet with a non-breakaway design that reduces the risk of the loss of the NVG.

[www.wilcoxind.com/G11](http://www.wilcoxind.com/G11)

### FEATURES & BENEFITS

- Horn interface securely locks NVG into place
- Force to overcome flip mechanism
- Maintains a very low profile on the helmet
- Ergonomic adjustments allow for one handed operation
- Compatible with all Wilcox shrouds (except lo-pro)
- Under Contract with U.S. ARMY
- Backed by Wilcox's 5 year warranty

### SPECIFICATIONS

WEIGHT:	6.35 oz
DIMENSIONS:	4.65" L x 2.58" W x 3.80" H
FORE/AFT TRAVEL:	1.6"
HEIGHT ADJUSTMENT:	.90"

Available Colors: ■-B

DESCRIPTION	PART NUMBER
G11 MOUNT ONLY	2830OG11

# G11 MOUNT KITS

FULL SYSTEM SOLUTIONS



## G19 KIT

G11, & ONE-HOLE SHROUD (MICH/ACH)



## G20 KIT

G11, & ONE-HOLE SHROUD (PASGT/RBR)

Available Colors:  -B

DESCRIPTION	NSN NUMBER	PART NUMBER
G11, & ONE-HOLE SHROUD (MICH/ACH)	5855-01-610-8704	56100G19
G11, & ONE-HOLE SHROUD (PASGT/RBR)	5855-01-612-5116	56100G20



# G21M MOUNT

BREAKAWAY NIGHT  
VISION GOGGLE MOUNT



## OVERVIEW

The G21 for the AN/PVS-21 allows firm attachment of the AN/PVS-21 goggle to a MICH/ACH helmet using Wilcox's line of shrouds or standard Army shroud. Pioneering the "break away" feature, this mount has built safety into it's design by disconnecting from the base under stress which reduces the potential for neck injury.

[www.wilcoxind.com/G21M](http://www.wilcoxind.com/G21M)

## FEATURES & BENEFITS

- Designed specifically for the AN/PVS-21
- Dovetail shoe interface securely locks NVG's into place
- Breakaway lever allows mount to break away under stress
- Two way flip mechanism provides a high and low stow
- Several points of adjustment for proper eye relief
- Compatible with all Wilcox shrouds (except lo-pro)
- Backed by Wilcox's 5 year warranty

## SPECIFICATIONS

WEIGHT: 6.72 oz  
DIMENSIONS: 2.75" L x 2.30" W x 3.60" H  
FORE/AFT TRAVEL: 1.44"  
HEIGHT ADJUSTMENT: .90"

Available Colors: ■ -B ■ -T

DESCRIPTION	PART NUMBER
G21M MOUNT ONLY	28300G21M

EXCLUSIVELY DISTRIBUTED THROUGH: **IBDT**  
BERETTA DEFENSE TECHNOLOGIES



# G21M MOUNT KITS

FULL SYSTEM SOLUTIONS



## G21 KIT

G21M, THREE-HOLE SHROUD & LANYARD (MICH/ACH)

Available Colors: ■ -B ■ -T

DESCRIPTION	PART NUMBER
G21M, THREE-HOLE SHROUD & LANYARD (MICH/ACH)	28300G21



# G30 MOUNT

FIXED NIGHT VISION GOGGLE MOUNT



## OVERVIEW

The Wilcox G30 Helmet Mount with Lanyard is a permanently fixed mount that securely locks the NVG onto any helmet drilled with a standard three-hole configuration. The G30 mount offers several adjustment points to create a precise fit and allows the operator to flip the NVG's out of the way when not being used.

[www.wilcoxind.com/G30](http://www.wilcoxind.com/G30)

## SPECIFICATIONS

WEIGHT:	6.35 oz
DIMENSIONS:	4.65" L x 2.58" W x 3.80" H
FORE/AFT TRAVEL:	1.40"
HEIGHT ADJUSTMENT:	.90"

## FEATURES & BENEFITS

- Maintains a very low profile on the helmet
- Dovetail shoe interface securely locks NVG's into place
- Lightweight/low profile three hole fixed bracket shroud
- Flip mechanism allows NVG to be stowed while not in use
- Several points of adjustment for proper eye relief
- Compatible with three-hole drilled helmets
- Backed by Wilcox's 5 year warranty

Available Colors:  -B  -T

DESCRIPTION	NSN NUMBER	PART NUMBER
G30 MOUNT & LANYARD	-B 5855-01-593-6418	28300G30
	-T 5855-01-593-6413	

## G22 MOUNT

NON-BREAKAWAY NIGHT VISION

GOGGLE MOUNT

### OVERVIEW

The G22 mount offers all the same benefits as the G24 minus the breakaway feature.

[www.wilcoxind.com/G22](http://www.wilcoxind.com/G22)

Available Colors:  -B  -T

DESCRIPTION	PART NUMBER
G22 MOUNT ONLY	28300G22



### SPECIFICATIONS

WEIGHT:	5.6 oz
DIMENSIONS:	4.4" L x 2.4" W x 2.6" H
FORE/AFT TRAVEL:	1.40"
HEIGHT ADJUSTMENT:	.90"

## G69 MOUNT

LIGHT PERMANENT MOUNT

### OVERVIEW

The G69 mount provides all the same features as the G66 with greater weight savings.

[www.wilcoxind.com/G69](http://www.wilcoxind.com/G69)

### FEATURES & BENEFITS

- Lightweight Lo Pro/mount, shroud & lanyard solution
- Mounts on to any helmet drilled with three-hole pattern
- Reduction of material with increased strength to weight ratio
- Increased vertical/horizontal travel for use with a wide array of protective masks, bridges and NVG's
- Permanent Lo Profile design to the helmet

Available Colors:  -B  -T

DESCRIPTION	PART NUMBER
G69 MOUNT & LANYARD	28300G69

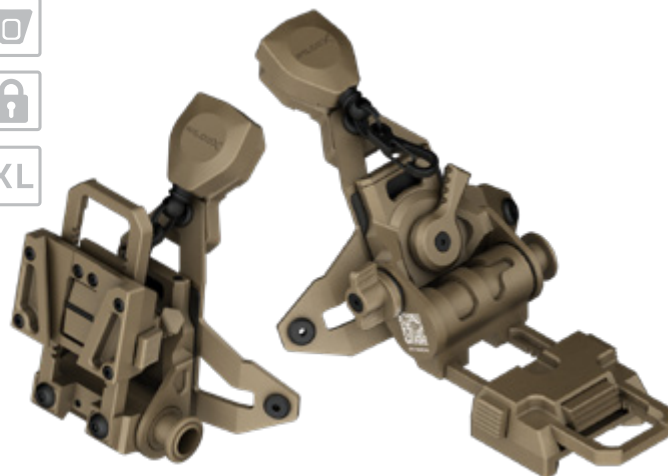

### SPECIFICATIONS

WEIGHT:	5.0 oz
DIMENSIONS:	4.75" L x 2.58" W x 3.80" H INTERNAL
POWER FORE/AFT TRAVEL:	1.40"
HEIGHT ADJUSTMENT:	.90"



# G29M MOUNT

## BREAKAWAY NIGHT VISION GOGGLE MOUNT



### OVERVIEW

The Wilcox G29M breakaway mount is the ultimate solution when your mission requires fast roping, maritime operations or quick entry or exit of mobility platforms. These conditions often pose snag hazards for NVG users. Pioneering the "break away" feature, this mount has built safety into its design by disconnecting from the base under stress which reduces the potential for neck injury.

[www.wilcoxind.com/G29M](http://www.wilcoxind.com/G29M)

### FEATURES & BENEFITS

- Designed specifically for the LUCIE NVG
- Dovetail shoe interface securely locks NVGs into place
- Breakaway lever allows mount to break away under stress
- Flip mechanism allows NVG to be stowed while not in use
- Several points of adjustment for proper eye relief  
Compatible with all Wilcox shrouds (except lo-pro)
- Backed by Wilcox's 5 year warranty

### SPECIFICATIONS

WEIGHT:	6.72 oz
DIMENSIONS:	3.95" L x 2.50" W x 3.10" H
INTERNAL POWER SOURCE:	N/A
RUNTIME:	N/A
FORE/AFT TRAVEL:	.90"
HEIGHT ADJUSTMENT:	.90"

Available Colors: ■ -B

DESCRIPTION	PART NUMBER
BREAKAWAY/MAGNET	28300G29M

# DPAM™ MOUNT

DUAL POWERED AVIATION MOUNT WITH INDICATOR LIGHT

## OVERVIEW

The Dual Powered Aviation Mount (DPAM) integrates the existing mounting capabilities of the GPNVG-18, F4949, F5050 and FGS NVG's for use on a ballistic or non-ballistic helmet. The DPAM features an onboard battery compartment that allows the operator to alternate between an external battery pack or utilize internal power from the mount.

[www.wilcoxind.com/DPAM](http://www.wilcoxind.com/DPAM)

## FEATURES & BENEFITS

- ANVIS mounting interface secures NVG's
- Internal power supply provides up to 8 hours of runtime
- Compatible with AERONOX/legacy external power supplies
- Features in-view low battery indicator (LBI) light
- NVG release button allows goggle to be stowed while not in use
- Compatible with both flight and ground style helmets
- 5 year warranty on mount, one year on electrical components

Available Colors:  -B  -T

DESCRIPTION	PART NUMBER
DPAM MOUNT ONLY	62101G02



## SPECIFICATIONS

WEIGHT:	4.38 oz
DIMENSIONS:	2.79" L x 2.47" W x 2.33" H
INTERNAL POWER SOURCE:	ONE (1) 123A 3V BATTERY
RUNTIME:	UP TO 8 HOURS
FORE/AFT TRAVEL:	N/A
HEIGHT ADJUSTMENT:	.90"

# DPAM™ MOUNT KITS

FULL SYSTEM SOLUTIONS



### G04 KIT

DPAM, INTERFACE PLATE, THREE-HOLE SHROUD & LANYARD

### AVIATOR SYSTEMS



### G06 / G07 KIT

DPAM & QUICK RELEASE/UNIVERSAL SHROUD

Available Colors:  -B  -T

DESCRIPTION	PART NUMBER
DPAM & UNIVERSAL, 3 HOLE	62100G04
DPAM & UNIVERSAL	62100G06
DPAM & QUICK RELEASE	62100G07



# AERONOX® MOUNT

## NIGHT VISION GOGGLE MOUNT



### OVERVIEW

The AERONOX® NVG Mount sets the standard in aviation NVG mounting. This lightweight structurally reinforced frame made of aerospace grade materials provides reliable operation under the toughest conditions. Its modular design is easily repairable which further reduces costs over the products lifetime. Compatible with a variety of both flight and ground style helmets, this mount is second to none.

[www.wilcoxind.com/AERONOX](http://www.wilcoxind.com/AERONOX)

### FEATURES & BENEFITS

- Reinforced carriage prevents critical failure during strenuous use
- NVG release button allows goggle to be stowed while not in use
- LBI (low battery indicator) alerts user of low battery life from power supply
- QD/universal interface provides secure attachment to air & ground helmets
- Low profile connector accepts AERONOX legacy power supplies
- Increased vertical adjustment to accommodate various helmet styles
- Retractable lanyard with breakaway feature prevents loss of NVG

### SPECIFICATIONS

WEIGHT: 3.8 oz  
 DIMENSIONS: 2.3" L X 2.7" W X 3.8" H  
 VERTICAL ADJUSTMENT: 1.3

Available Colors: ■-B

DESCRIPTION	PART NUMBER
AERONOX MOUNT ONLY	62108G01
AERONOX (COMPLETE KIT)	62108G05

# AERONOX® BATTERY PACK

MODULAR/REPAIRABLE POWER SUPPLY

## OVERVIEW

The AERONOX Battery Pack provides the most advanced solution to powering aviation night vision systems. The low profile, lightweight design is perfect for reducing user strain over extended duration. Made entirely of reinforced, molded polymer, the pack is strong enough to withstand the toughest mission environments. Should damage occur, it's modular design is completely repairable further reducing costs over the product's lifetime.

## FEATURES & BENEFITS

- Recessed toggle switch utilizes traditional "ON - OFF - ON" modes
- Metal latches provide fast and secure access to battery channels
- Lemo connector provides power to AERONOX/legacy NVG mounts
- Drop in battery channels eliminate the need for battery trays
- LBI (low battery indicator) alerts user of low battery life from power supply
- Compatible with hook and loop as well as dovetail mounting interfaces

Available Colors: ■ -B

DESCRIPTION	PART NUMBER
AERONOX BATTERY PACK ONLY	62108G10



## SPECIFICATIONS

WEIGHT (WITHOUT BATTERIES):	4.0 oz
MATERIAL:	HIGH STRENGTH POLYMER / ALUMINUM
DIMENSIONS:	4.2" L x .75" W x 2.62" H
POWER SOURCE:	AA
POWER REQUIREMENT / CAPACITY	TWO (2) AA / FOUR (4) AA

# AERONOX® GROUND INTERFACE

INTERFACE PLATE FOR GROUND HELMETS

## OVERVIEW

The AERONOX Ground Interface allows NVG mounts with the 4 stud QD configuration to be mounted to a ground style helmet. Compatible with all one and three-hole shroud interfaces.

## FEATURES & BENEFITS

- QD interface allows for quick and easy mounting and removal.
- Release lever ensures a solid fit into ground style shrouds
- Release button provides fast and familiar removal of NVG mount
- Compatible with one-hole, three-hole and rail shroud interfaces

Available Colors: ■ -B

DESCRIPTION	PART NUMBER
AERONOX GROUND INTERFACE	62108G23



## SPECIFICATIONS

WEIGHT:	2.4 oz
---------	--------

# RATCHET STRAP SHROUD

NO/ONE HOLE HELMET SHROUD

[www.wilcoxind.com/RATCHET-STRAP-SHROUD](http://www.wilcoxind.com/RATCHET-STRAP-SHROUD)



Compatible MICH/ACH helmets

Available Colors:  -B  -T

DESCRIPTION	PART NUMBER
WITH LANYARD (MICH/ACH)	56100G01
NO LANYARD (MICH/ACH)	56100G02

# ONE-HOLE SHROUD

ONE HOLE HELMET SHROUD

[www.wilcoxind.com/ONE-HOLE-SHROUD](http://www.wilcoxind.com/ONE-HOLE-SHROUD)



Compatible MICH/ACH helmets

Available Colors:  -B  -T

DESCRIPTION	NSN NUMBER	PART NUMBER
WITH LANYARD (MICH/ACH/ECH)	-B 5855-01-593-7049 -T 5855-01-593-7377	56100G03
NO LANYARD (MICH/ACH/ECH)		56100G04

# THREE-HOLE SHROUD

THREE-HOLE HELMET SHROUD

[www.wilcoxind.com/THREE-HOLE-SHROUD](http://www.wilcoxind.com/THREE-HOLE-SHROUD)



LANYARD

NO LANYARD

Compatible with three-hole helmets

Available Colors:  -B  -T  -G  -F

DESCRIPTION	NSN NUMBER	PART NUMBER
WITH LANYARD	-B 5855-01-617-1935 -T 5855-01-617-1980	56100G35
NO LANYARD	-B 5855-01-610-9318 -T 5855-01-610-9315	56100G34

# HYBRID SHROUD

ONE/THREE HOLE HELMET SHROUD

[www.wilcoxind.com/HYBRID-SHROUD](http://www.wilcoxind.com/HYBRID-SHROUD)



ONE OR THREE-HOLE  
COMPATIBLE

Compatible with one or three-hole and ECH helmets

Available Colors:  -B  -T

DESCRIPTION	PART NUMBER
WITH LANYARD	56100G39
NO LANYARD	56100G38



## WLS SHROUD

WILCOX LIGHTWEIGHT SHROUD

[www.wilcoxind.com/WX-LIGHTWEIGHT-SHROUD](http://www.wilcoxind.com/WX-LIGHTWEIGHT-SHROUD)



UNIVERSAL

Compatible with three-hole helmets

Available Colors:  -B  -T  -G  -F

DESCRIPTION	PART NUMBER
LANYARD (UNIVERSAL)	56108G01
NO LANYARD(UNIVERSAL)	56108G02
LANYARD (LO-PRO)	56109G01
NO LANYARD (LO-PRO)	56109G02

## WMS SHROUD

WILCOX MODULAR SHROUD

[www.wilcoxind.com/WX-MODULAR-SHROUD](http://www.wilcoxind.com/WX-MODULAR-SHROUD)



UNIVERSAL

Compatible with three-hole helmets

Available Colors:  -B  -T  -G  -F

DESCRIPTION	PART NUMBER
LANYARD (UNIVERSAL)	50200G01
NO LANYARD(UNIVERSAL)	50200G02
LANYARD (LO-PRO)	50201G01
NO LANYARD (LO-PRO)	50201G02

## INTERFACE PLATE

ADAPTER FOR DPAM, GSGM & G24R

[www.wilcoxind.com/INTERFACE-PLATE](http://www.wilcoxind.com/INTERFACE-PLATE)



Compatible with DPAM, GSGM and G24R mounts

Available Colors:  -B  -T

DESCRIPTION	PART NUMBER
INTERFACE PLATE	62113G01



# AN/PVS-14 BRIDGE

## BINOCULAR BRIDGE SYSTEM



### OVERVIEW

The AN/PVS-14 binocular bridge provides versatility allowing the end user to wear a PVS-14 as a monocular or add a second PVS-14 or a SkeetIR<sup>®</sup>x thermal for binocular needs. Offered in a dovetail shoe or horn interface (sold separately), the PVS-14 binocular bridge fits securely into our G24 or G11 mount allowing the binocular configuration to be positioned into operational, high ready and stowed positions, the same as in a monocular configuration.

[www.wilcoxind.com/ANPVS-14](http://www.wilcoxind.com/ANPVS-14)

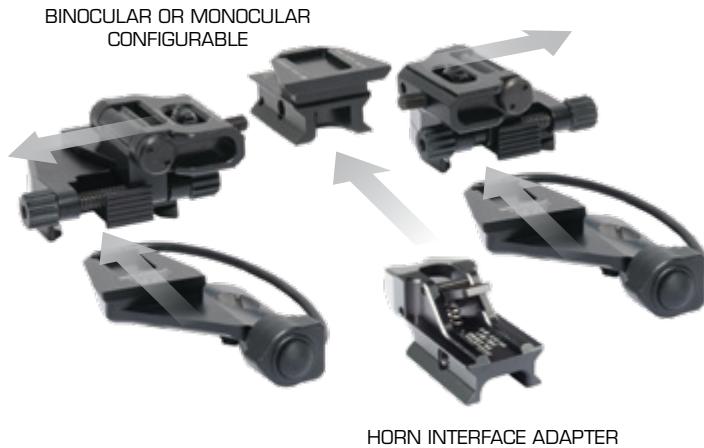

### SPECIFICATIONS

WEIGHT: 7.37 oz  
DIMENSIONS: 4.5" L x 1.3" W x 2.1"H  
INTERFACE: DOVETAIL OR HORN INTERFACE SOLD SEPARATELY

Available Colors:     -B

DESCRIPTION	PART NUMBER
AN/PVS-14 BRIDGE	61300G16
HORN INTERFACE ADAPTER	61301G02

# MINI N-SEAS BRIDGE

## BINOCULAR BRIDGE SYSTEM

### OVERVIEW

The Mini N-SEAS Binocular Bridge offers the operator the versatility of running just one, or two Mini N-SEAS NVG(s). two magnet arms power off the NVG(s) when pivoted out of sight.

[www.wilcoxind.com/MINI-SEAS](http://www.wilcoxind.com/MINI-SEAS)

### SPECIFICATIONS

WEIGHT:	5.64 oz
DIMENSIONS:	4.4" L x 2.7" W x 1.1"
INTERFACE:	DOVETAIL

# MUM-14 BRIDGE

## BINOCULAR BRIDGE SYSTEM

### OVERVIEW

The MUM-14 Binocular Bridge offers the operator the versatility of running just one, or two MUM-14 NVG(s). The bridge flips up allowing the operator to stow the thermal or NVG flat against the helmet.

[www.wilcoxind.com/MUM-14](http://www.wilcoxind.com/MUM-14)

### SPECIFICATIONS

WEIGHT:	4.7 oz
DIMENSIONS:	3.5" L x 2.12" W x .76"
INTERFACE:	DOVETAIL

# SKEETIR<sup>®</sup>x BRIDGE

## BINOCULAR BRIDGE SYSTEM

### OVERVIEW

The SKEETIRx binocular bridge allows the use of one or two BAE SKEETIRx devices as either a monocular or binocular. The bridge flips up allowing the operator to stow the thermal or NVG flat against the helmet.

[www.wilcoxind.com/SKEETIRx](http://www.wilcoxind.com/SKEETIRx)

### SPECIFICATIONS

WEIGHT:	6.08 oz
DIMENSIONS:	4.5" L x 1.3" W x 2.1" H
INTERFACE:	DOVETAIL OR HORN



Available Colors: ■-B

DESCRIPTION	PART NUMBER
MINI N-SEAS BRIDGE	61300G02



Available Colors: ■-B

DESCRIPTION	PART NUMBER
MUM-14 BRIDGE	61300G05



Available Colors: ■-B

DESCRIPTION	PART NUMBER
SKEETIRx BRIDGE	61300G06



# SKULL LOCK™

## NVG SOFT HEAD HARNESS

### OVERVIEW

The Wilcox Skull Lock Head Mount is the operator's choice when wearing a helmet is not an option. Combining the Wilcox head mount with the Team Wendy Cam Fit Retention System, the Skull Lock provides a low profile, lightweight, and durable solution in the absence of a helmet requiring the use of a night vision goggle or any other accessory utilizing the universal interface plate. The universal receiver is made of aerospace grade metal mount, with nylon webbing and high strength polymer; this combat proven design has been fielded by both the US Special Operations community and Domestic Law Enforcement agencies alike. With several adjustment points the Skull Lock is designed to provide unmatched fit and comfort for the operator while providing a sturdy platform for utilizing any head mounted device.

Compatible with the full line of Wilcox L4 series NVG mounts, the Skull Lock is just as versatile as it is durable and provides outstanding control and support while operating NVGs. This system also accepts the Wilcox NVG Lanyard to provide an extra level of insurance during operations. The option to add an adjustable counterweight to the back of the system guarantees balance no matter what NVG system is being used.

[www.wilcoxind.com/Skull-Lock](http://www.wilcoxind.com/Skull-Lock)

### FEATURES & BENEFITS

- Several adjustment points provide for the operators fit and comfort.
- Maintains a very low-profile stance on the head.
- Is compatible with the entire line of L4 Wilcox NVG Mounts.
- Ergonomically positioned mechanical adjustments allow easy one-handed use while handling a weapon.
- Weight storage basket allows for NVG weight distribution.

### MOUNT COMPATIBILITY

- Compatible with the full line of Wilcox L4 series NVG mounts
- \* DPAM and GSGM mounts require interface plate adapter sold separately.*

### SPECIFICATIONS

WEIGHT: 7.3 oz

SIZING: SMALL - 7.25" OR LESS / LARGE- 7.25 OR MORE

DESCRIPTION	PART NUMBER
SKULL LOCK FIXED	26000G02
SKULL LOCK HEAD MOUNT-LITE SMALL	26000G05
SKULL LOCK HEAD MOUNT-LITE LARGE	26000G06

### SKULL LOCK™ FIXED



### SKULL LOCK™ HEAD MOUNT-LITE



# AN/PVS-14 ARM

## MONOCULAR ARM SYSTEM

The PVS-14 arm offers left and right eye capability, providing a solid mounting platform and several adjustment points for a precise fit. Utilizing the same dovetail shoe interface as seen on our weapon flip mounts, this arm transitions seamlessly from helmet to weapon.



LEFT OR RIGHT EYE CONFIGURABLE

### SPECIFICATIONS

WEIGHT: 4.8 oz  
 DIMENSIONS: 3.2" L x 2.7" W x 2.1"H  
 INTERFACE: DOVETAIL OR HORN

Available Colors:     -B

DESCRIPTION	PART NUMBER
AN/PVS-14 ARM WITH DOVETAIL INTERFACE	61300G13
AN/PVS-14 ARM WITH HORN INTERFACE	61300G14
AN/PVS-14 AUTO OFF SHOE ONLY	61313G01

# NVG LENS COVERS

## FILTER COVER/PROTECTIVE LENS ASSEMBLIES



FILTER COVER



PROTECTIVE LENS ASSEMBLY

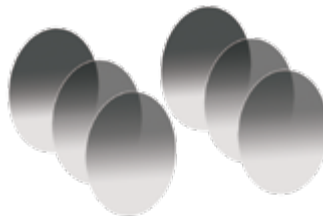

REPLACEMENT LENS INSERT KIT (x 6)



AN/PVS-15/18 ASSEMBLY KIT

DESCRIPTION	PART NUMBER
FILTER COVER FOR AN/PVS-7/14/15/18/23 (5050)/31/BNVD/MUM-14	34000G03
FILTER COVER FOR AVS-6/9 (F4949)	34000G04
PROTECTIVE LENS FOR AN/PVS-14	56400G04
PROTECTIVE LENS FOR AN/PVS-15/18	56400G01
AN/PVS-15/18 ASSEMBLY KIT	56400G02
REPLACEMENT LENS KIT FOR AN/PVS-14/15/18	56400G03

# NVG LANYARD KITS

## NVG RETENTION SYSTEMS



RATCHET STRAP  
SHROUD LANYARD



U.S. ARMY  
SHROUD LANYARD



THREE-HOLE  
SHROUD LANYARD



THREE-HOLE  
BRACKET LANYARD



ONE-HOLE  
SHROUD LANYARD

Available Colors: ■ -B ■ -T ■ -G ■ -F

DESCRIPTION	NSN NUMBER	PART NUMBER
RATCHET STRAP LANYARD	-B 5855-01-566-7434 -T 5855-01-566-7423	41400G02
U.S. ARMY LANYARD	5855-01-566-7444	41400G03
THREE-HOLE / HYBRID LANYARD		41400G08
THREE-HOLE BRACKET LANYARD	-B 5855-01-566-7429 -T 5855-01-566-7431	41400G01
ONE-HOLE LANYARD	-B 5855-01-593-6403 -T 5855-01-593-6401	56100G07
THREE-HOLE BRACKET LANYARD/SPACER	-B 5855-01-566-7429 -T 5855-01-566-7431	62100G20

# NVG SHOE INTERFACES

## NVG INTERFACES



AN/PVS-15/15A  
SHOE



AN/PVS-7B  
SHOE



AN/PVS-31  
SHOE

Available Colors: ■ -B

DESCRIPTION	NSN NUMBER	PART NUMBER
AN/PVS-15/15A SHOE	5855-01-566-7436	14003G01
AN/PVS-7B SHOE	5855-01-566-6772	14004G01
AN/PVS-31 SHOE		14012G01





# LIFE SUPPORT SYSTEMS

Wilcox stands committed to providing our customers with the most advanced and capable life support system solutions in the world today, designed and developed with our “systems approach to combat operations” and focused to maximize the survivability of today’s warfighter. Our innovative and customer led product design and evolution has enabled our range of hybrid life support systems to adapt, respond, and predict the ever changing needs of our end users across the globe.

The Hybrid PATRIOT 5510 is the one and only fully CE certified Hybrid Life Support System on the world market today, reinforcing the “inclusive” systems process Wilcox conducts to develop an all in one holistic solution to respiratory protection. These actions enable the customer to adjust to conditions on the fly, minimizing equipment configuration actions and maximizing time on target and mission effectiveness.

The Hybrid PATRIOT 5510 gives you all the features you enjoy from the original PATRIOT unit in one unit, and the dynamic ability to change between configurations with the turn of a dial, no additional fittings or part changes required. In addition to these features the Hybrid PATRIOT 5510 offers state-of-the-art monitoring capabilities and the largest bottle size on the market which enables the user to stay on target longer. Historically, operators would need more than one system and several sets of fittings and other equipment to achieve the four breathing configurations offered by the Hybrid PATRIOT 5510 Life Support System.

From urban, large structure rescue CONOPS to CBRN and follow on Subterranean CONOPS, today’s real world contingencies require maximum flexibility and the critical interface of network centric operations as well as an ability to fully understand where our critical assets are located within the area of responsibility. The dynamic capability options of the Hybrid PATRIOT 5510 are further enabled with the system interface mission software from Blueforce Development. Together they provide solutions to meet any mission profile with command and control insight, greater equipment capacity, enhanced situational awareness enabling the customer to make superior decisions, increase operational tempo, and enhance overall survivability. The Hybrid PATRIOT 5510 continues to serve without peer in CBRN protection.

[www.wilcoxind.com/LifeSupport](http://www.wilcoxind.com/LifeSupport)

HYBRID PATRIOT 5510 SYSTEM

HYBRID PATRIOT 5510 GAS MASKS

HYBRID PATRIOT 5510 SPARE PARTS & ACCESSORIES

COMPRESSED AIR CHARGING ADAPTERS

QUICK RESPONSE KIT

EXOTHERMIC TORCH KITS & ACCESSORIES



**BTAC**

## NETWORKED ENABLED CAPABILITY

### ENHANCED SITUATIONAL AWARENESS

- Monitoring and sharing of PSI/BAR
- Monitoring and sharing of operating mode
- Monitoring and sharing of battery and power
- Alerts when other team members exceed thresholds
- Receipt and acknowledgment of PAR checks & EVACS
- Integrates with Blueforce cognitive services/AI
- Plugin for MSA ALTAIR 4xr and 5x multi-gas sensors
- Plugin for Samsung GEAR S3 watch/wearable
- Storage of events for after-action and maintenance



SEE BTAC IN ACTION

# HYBRID PATRIOT 5510®

## CBRN HYBRID LIFE SUPPORT SYSTEM



### OVERVIEW

In partnership with Blueforce®, Wilcox is proud to design and manufacture the first certified state-of-the-art life support system. With exclusive 5500psi bottles, the Hybrid PATRIOT 5510 offers responders four breathing modes – SCBA, PAPR, APR, and SAR. The Hybrid PATRIOT 5510 is the next generation in hybrid life support systems offering innovative electronics, equipped for CBRN environments, improved monitoring capability, revolutionary power supply system, and world class breaching/cutting torch options and is the only ISO certified hybrid system.

[www.wilcoxind.com/Patriot5510](http://www.wilcoxind.com/Patriot5510)

### FEATURES & BENEFITS

- CBRN Dual-Mode Apparatus BS 8468-5:2011 certified
- Dual 5500 PSI (379 Bar) Cylinder (60 minutes of SCBA air)
- Battery Speed Loader (AA or CR123 battery compatible)
- Ergonomic Lightweight Backpack Carrying System
- First Responder Respirator (FRR) Gas Mask
- 2 Scott CBRN Cap1 Filters
- Improved Monitoring Capability
- Revolutionary Power Supply System
- Configurable for Subterranean CONOPS
- Low Pressure SAR Line Connection
- Situational Awareness Electronics Package
- CE Certified

DESCRIPTION	NSN NUMBER	PART NUMBER
HYBRID PATRIOT 5510 - 5500 PSI - SINGLE AIR		60001G04
HYBRID PATRIOT 5510 - 5500 PSI - DUAL AIR		60001G02
HYBRID PATRIOT 5510 - 5500 PSI - DUAL AIR with TORCH		60001G09
HYBRID PATRIOT 5510 - 379 BAR - SINGLE AIR	3433016702262	60001G05
BATTERY SPEED LOADER CR123		60015G01
FRR MASK INTERFACE		60016G02
ASSEMBLY - DECON FILTER ADAPTER		60019G01
CYLINDER - PATRIOT 5510 RESCUE 5500 PSI	8120226315362	60020G01
CYLINDER - PATRIOT 5510 RESCUE 379 BAR		60020G21
CYLINDER - PATRIOT 5510 5500 PSI		60020G02
CYLINDER - PATRIOT 5510 379 BAR		60020G22
RESCUE WHIP	4720226316866	60020G06
CYLINDER TORCH - PATRIOT 5510 3000 PSI		60020G13
CYLINDER TORCH - PATRIOT 5510 200 BAR		60020G23
CHARGING ADAPTER - 379 BAR		60022G01
CHARGING ADAPTER - CGA347		60022G02
CONTAINER - WITH FOAM INSERTS SCOTT PATRIOT 5510 STORAGE		60000G06

IN PARTNERSHIP WITH:

**blueforce**  
DEVELOPMENT



# THE ONLY CERTIFIED HYBRID SOLUTION

Our innovative and customer led product design and evolution has enabled our range of hybrid life support systems to adapt, respond and predict the ever changing needs of our end users across the globe. The Hybrid Patriot 5510® provides an all-in-one holistic solution to respiratory protection allowing the user to adjust to conditions on the fly, minimizing equipment configuration and maximizing time on target. The Hybrid Patriot 5510 represents the next generation in high end tactical respirator protection capability and includes Self-Contained Breathing Apparatus (SCBA) mode, Powered Air Purifying Respirator (PAPR) mode, Air Purifying Respirator (APR) mode, and Supplied Air Respirator (SAR) mode.

## HIGH PERFORMANCE PROTECTION

Developed in response to exacting customer feedback, the Hybrid Patriot 5510 has been designed to maximize operator time on target while at the same time increase comfort, improve ease of movement and significantly reducing operator fatigue.

The Hybrid Patriot 5510 is equipped for CBRN environments via specialized materials and design. The system uses high performance, reliable pneumatics which provide low breathing resistance and excellent dynamic performance. Integrated APR/PAPR modes further enhance operational capability in providing reduced breathing resistance options via two Cap1 filters, the latter being located behind waterproof covers on the central chassis.

Furthermore, tactile low pressure and power alarms provide covert signaling of breathable air and battery power respectively. Advanced on-board electronics feature improved real time monitoring capabilities including cylinder pressure (PSI/Bar), battery, respiratory protection mode, as well as end user location and other sensor telemetry. This information can be shared amongst deployed teams and their command using mobile devices or tablets.

## RANGE OF SPECIFICATIONS

The Hybrid Patriot 5510 is a holistic respiratory solution to meet any mission profile with the exclusive BlueForce tactical situational awareness software package included. Other features include:

- Integrated SCBA/PAPR/APR/SAR
- Integrated VIP extraction/RIT capability
- Integrated breaching torch accessory with Hellboy handle
- FRR respirator that delivers the highest protection factors available on the market with unparalleled comfort, moisture removal and rapid re-hydration capability
- 30 minute duration in 5500psi/379bar air cylinders
- Modular backpack for 60min or 30min configurations

# AVAILABLE CONFIGURATIONS

ADAPTABLE FOR ANY MISSION

CE 672424 CE 672426 CE 2797

The Patriot 5510 was tested and approved at BSI to CBRN EN137 and BSA8468 standards which included Dual Mode Apparatus Respiratory Protection.



## RESPONDER I CONFIGURATION (Single Air)

- Single 5500 PSI or 379 bar cylinder [capable of providing 30 minutes of SCBA air]
- Emergency Breathing Support System (EBSS)
- Battery Speed Loader
- Chemically Hardened Chassis
- Adjustable Lightweight Backpack Carrying System
- 2 SCOTT CBRN CAP 1 Filters
- SCOTT FRR Gas Mask

## RESPONDER II CONFIGURATION (Dual Air)

- 2, Single 5500 PSI or 379 bar cylinders [each capable of providing 30 minutes of SCBA air]
- Emergency Breathing Support System (EBSS)
- Battery Speed Loader
- Chemically Hardened Chassis
- Adjustable Lightweight Backpack Carrying System
- 2 SCOTT CBRN CAP 1 Filters
- SCOTT FRR Gas Mask

## RESPONDER III CONFIGURATION (Dual Air/Breach)

- 2, Single 5500 PSI or 379 bar cylinders [each capable of providing 30 minutes of SCBA air]
- Single 3000 PSI Oxygen cylinder with Hellboy™ exothermic cutting torch (sold separately)
- Emergency Breathing Support System (EBSS)
- Battery Speed Loader
- Chemically Hardened Chassis
- Adjustable Lightweight Backpack Carrying System
- 2 SCOTT CBRN CAP 1 Filters
- SCOTT FRR Gas Mask

# WILCOX ELECTRONICS TIES TO BTAC COMMAND POST

Blueforce Tactical (BTAC) is a mobile software application that enables the rapid formation of tactical teams and facilitates information sharing amongst team members using Android or iOS devices brought to the tactical environment. The software enables shared situational awareness and extended presence of people, sensors, and services; and it provides secure information exchange between them using standard cellular, 3G/4G/LTE, FirstNet, WIFI, WiMAX, satellite, mesh, and/or mobile ad-hoc networks.

Blueforce's Extended Presence Protocol fuses geolocation, interior network location, health, and body-worn/person carried sensor data into a presence heartbeat that is light on the network, yet provides shared tactical awareness as to where your people are and what's going on around them. BTAC provides a software plug-in interface for integration of a multitude of sensor types. The Hybrid Patriot 5510 plugin enables users to monitor the status of their Hybrid Patriot 5510 and receive vibration and tones when parameters like battery and PSI move outside of acceptable ranges. Teammates may monitor each other providing a mission critical solution for life safety and operational efficiency for team members and commanders.

## APPLICATION AREAS

BlueForce Tactical is suitable for a wide range of in the field applications, not limited to:

- Special Operations/SWAT
- Specialist Military and Law Enforcement teams
- Civil Support/CBRN/HAZMAT
- EOD and Bomb Teams
- Technical Rescue/SAR

## AUTONOMOUS MONITORING

Blueforce M2M Cloud Service software provides autonomous (unmanned) monitoring of deployed BTAC and Hybrid Patriot 5510 users and provides:

- Panic and/or Offline Monitoring
- Geofence Monitoring
- Diagnostic collection of Hybrid Patriot 5510 data for maintenance and/or after-action
- Comprehensive notification framework to include SMS, email, and workflow messaging services.

## COMMAND AND CONTROL

Blueforce Web Command Center provides attended monitoring of deployed BTAC and Hybrid Patriot 5510 users and provides:

- Real-time and historical tracking of subscribed BTAC users.
- Real-time monitoring and notification of Hybrid Patriot 5510 sensor warnings and sensor alarms.
- Secure text chat and "listen live".
- Charting of Hybrid Patriot 5510 historical data.
- Accelerometer, gyroscope, and monitoring of battery status of any subscribed BTAC endpoint.





## SECURITY

Blueforce Tactical for mobile is built on a FIPS 140-2 cryptographic provider and provides the following:

- AES-256 encryption for at rest data; X.509 V3 and/or SASL authentication support along with LDAP/AD directory services
- AES 256-bit TLS for data link session encryption
- Content Access Controls: End user may limit what data is sent and to which subscribed endpoint.

# BTAC®





# QUICK RESPONSE KIT

## EMERGENCY SCBA

### OVERVIEW

The QRK (Quick Response Kit) provides operators and first responders with a simple, compact and lightweight 30 minute SCBA (self contained breathing apparatus) system that can be utilized on its own or used in conjunction with the Hybrid Patriot 5510®. The QRK is ideal for personnel who are tasked with containing situations and offering immediate protection and assistance until backup arrives. The QRK's compact design allows it to easily be stowed/concealed inside the custom sling pack and quickly deployed when needed. The pack features several pockets, pouches, MOLLE and Hook and loop for other essential items.

Compatible with the Hybrid Patriot 5510, The QRK can be used for SubT, man down rescue, VIP extraction, hand-off air supply and undercover/low vis operations where hazardous atmospheric environments are present or potentially exist. Once the QRK is attached onto the Hybrid Patriot 5510 center chassis, the end user is provided with the same capabilities (SCBA, PAPP (powered air purifying respirator), APR (air purifying respirator) and SAR (supplied air respirator) offered by the Hybrid Patriot 5510.

[www.wilcoxind.com/QRK](http://www.wilcoxind.com/QRK)

### FEATURES & BENEFITS

- 30 Minutes of SCBA capability and CBRN protection
- Simple to use, compact and lightweight design
- Compatible with Hybrid Patriot 5510 for additional capability
- Pack accommodates small firearms, magazines, med kits etc.
- Ideal for MIL, LE, first responders and VIP/GOV officials
- System available with either PSI or BAR pressure gauge
- EU Certification TYPE 2 pending

### SPECIFICATIONS

WEIGHT (COMPLETE SYSTEM WITH AIR): 15 lbs  
 DIMENSIONS: 23" L x 6" W x 9" H  
 OPERATIONAL CAPABILITY (SCBA): 30 Minutes

Available Colors: ■ -B

DESCRIPTION	NSN NUMBER	PART NUMBER
QRK ASSEMBLY - BAR		60020G32
QRK ASSEMBLY - PSI		60020G33
RESCUE WHIP	4720226316866	60020G06
FRR MASK	4240016702294	60056PO4-02
RESCUE CYLINDER	8120226315362	60020G01





# CUTTING TORCH

## EXOTHERMIC BREACHING TORCH



### OVERVIEW

Our 233ci Cutting Torch system is lightweight, low profile and scalable to meet your mission requirements. Using fuel rods promoted by pure oxygen, our system will quickly get you through what stands in your way when other breaching methods aren't suitable for technical or tactical reasons.

[www.wilcoxind.com/Cutting-Torch](http://www.wilcoxind.com/Cutting-Torch)

### FEATURES & BENEFITS

- Cuts through obstacles enhancing breaching capability
- Light and portable design for ease of carry & deployment
- Cylinder flow valve allows quick on/off & adjustment of O2
- Pressure indicator displays remaining cylinder pressure
- Quick connect fittings on cylinder, hose & handle
- CGA charging port is quickly accessible for O2 charging

### SPECIFICATIONS

WEIGHT: 192 oz  
DIMENSIONS: 5.0" DIA x 22.5" H  
CAPACITY @ 3,000 PSI: 27.5 cu. ft.

DESCRIPTION	PART NUMBER
TORCH ASSEMBLY	40400G19
TORCH KIT	40400G21
QUICK RESPONSE TORCH KIT	40400G22

# OXYGEN SUPPLY SYSTEM

## EXOTHERMIC BREACHING TORCH

### OVERVIEW

For your fortified and very difficult entry scenarios the O2 Exothermic Torch Supply System is the workhorse that will get you where you need to go. With twin 550ci cylinders protected by a portable ultra-high impact co-polymer case this system serves as an excellent exothermic training device due to the amount of oxygen being supplied and its dual whip configuration. The recharging and operational controls remain the same as our other torching systems and the system is designed to be rolled or transported into place.

### SPECIFICATIONS

WEIGHT (WITH OXYGEN):	1,184 oz
DIMENSIONS:	20.6" L x 12.5" W x 31.6" H
CYLINDER VOLUME:	1,100 cu. in.
CAPACITY @ 3,000 PSI:	130 cu. ft.



DESCRIPTION	PART NUMBER
OXYGEN SUPPLY SYSTEM	41100G02

# HELLBOY™

## MODULAR TORCH HANDLE

### OVERVIEW

The Hellboy exothermic cutting torch handle sets our system apart. With the O2 flow control wheel is easily controlled by the operator's thumb, allowing for nimble changes of airflow. The quick change collet adjusts for different size fuel rods without removing the head enabling you to stay on target longer. The handle also features a trigger safety lock that prevents unintended operation of the system. Made of heat resistant polycarbonate, the Hellboy™ Torch Handle stands up to the high temperatures generated with exothermic torching.

[www.wilcoxind.com/Hellboy](http://www.wilcoxind.com/Hellboy)

### FEATURES & BENEFITS

- Quick change collet accepts multiple sizes of fuel rods
- Trigger mechanism provides ergonomic grip
- Safety lock prevents ignition when stowed or dropped
- On the fly thumb-wheel provides fine adjustment of O2 flow
- Quick connect securely attaches to hose assembly

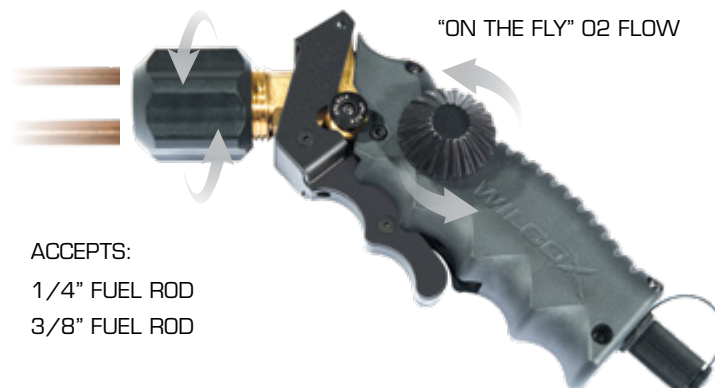

ACCEPTS:  
1/4" FUEL ROD  
3/8" FUEL ROD

### SPECIFICATIONS

WEIGHT:	19.2 oz
DIMENSIONS:	7.0" L
ROD COMPATIBILITY:	1/4" & 3/8"

DESCRIPTION	PART NUMBER
TORCH HANDLE	54001G03



# TORCH ACCESSORIES

BACKPACKS, RODS, STRIKERS, GAUGES & HOSES



233ci BACKPACK



FUEL ROD QUIVER

DESCRIPTION	PART NUMBER
233 CI BACKPACK	21200P13
FUEL ROD QUIVER	21200P14



1/4" & 3/8" FUEL RODS



CUTTING TORCH STRIKER CABLE

DESCRIPTION	NSN NUMBER	PART NUMBER
TWELVE (12) 1/4" FUEL RODS	6116016700626	F1718
TWELVE (12) 3/8" FUEL RODS		F1719
CUTTING TORCH STRIKER CABLE		40401G24



GAUGES



QUICK CONNECT HOSE ASSEMBLY

DESCRIPTION	PART NUMBER
OXYGEN PRESSURE GAUGE	40008G01
52" QUICK CONNECT HOSE ASSEMBLY	40401G03
60" QUICK CONNECT HOSE ASSEMBLY	40401G10
120" QUICK CONNECT HOSE ASSEMBLY	40401G11

# WARRANTY INFORMATION

Wilcox Industries Corp. ("WX") offers a Standard limited warranty ("Standard Limited Warranty") that its product will be free from defects in material and workmanship under proper usage for the warranty period as specified herein ("Warranty Period") from the date of original shipment from WX if purchased through an authorized sale. To make a warranty claim, the product and purchasing documents must be returned to WX (at user's expense) and WX will have the option (in its sole discretion) to exchange or recondition the product, that after examination by WX is determined to be defective, and return the product via pre-approved carrier at user's expense. In the event WX mount and shroud hardware is used with a non-WX product, the Warranty Period for the WX product is limited to one (1) year. This Standard Limited Warranty is void if the date of manufacture which is laser engraved on the product is defaced, modified, or altered. This Standard Limited Warranty is only for products purchased directly from WX or an authorized reseller. Items purchased via eCommerce such as eBay, Craigslist, Amazon, or any other online marketplaces are not eligible for the Limited Warranty.

The Standard Limited Warranty does not include damages arising from improper use, maintenance, repairs, installation or storage, abuse, misuse, misapplication, vandalism, negligence, neglect, normal wear and tear, or any other circumstances over which WX has no control.

Nothing contained in any operation manual, instructions, catalog, or written materials shall amend these terms.

WX MAKES NO OTHER WARRANTIES, EXPRESS OR IMPLIED. WX SPECIFICALLY DISCLAIMS ALL OTHER WARRANTIES, EXPRESS OR IMPLIED, INCLUDING BUT NOT LIMITED TO, THE WARRANTIES OF MERCHANTABILITY AND/OR FITNESS FOR A PARTICULAR PURPOSE.

The Standard Limited Warranty is purchaser's sole and exclusive remedy for warranty coverage, WX conduct, or for any other claim or cause of action against WX. WX shall not be responsible for any direct, incidental, or consequential damages, including without limitation, costs resulting from labor charges, repairing surrounding product, replacements, or any delays.

This language supersedes any purchase order. WX specifically does not agree with any conflicting terms. No employee or agent may modify these terms. WX does not accept returns or exchanges.

# SERVICE CALL INFORMATION

## AUTHORIZATION

Wilcox Industries Corp. must be contacted to assign a Service Call (SC) Number prior to return shipment.

To expedite repair of the item purchased under a military contract, Wilcox Industries Corp. will accept any package at the address below, clearly marked:

**Wilcox Industries Corp.**

**SC # \_\_\_\_\_**

**25 Piscataqua Drive  
Newington, NH 03801  
603-431-1331**

Please be sure to retain your packing list as proof of delivery date when making a warranty claim. If proof of delivery acceptance is not available, the warranty period shall start from the date of manufacture laser engraved on the item. Warranty is void if date of manufacture is defaced.

Items should be securely packaged, accompanied by a letter including sender's name, address, daytime phone number, date of purchase, date of manufacture, lot number, and a description of the problem or work to be performed.

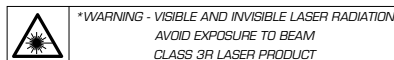
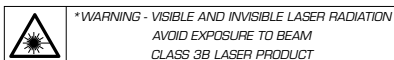



## GLOBAL MASTER DISTRIBUTION NETWORK

Wilcox has an extensive list of Dealers and Master Distributors around the world. Visit [wilcoxind.com/contact](http://wilcoxind.com/contact) to view our entire Master Distributors list segmented by region.

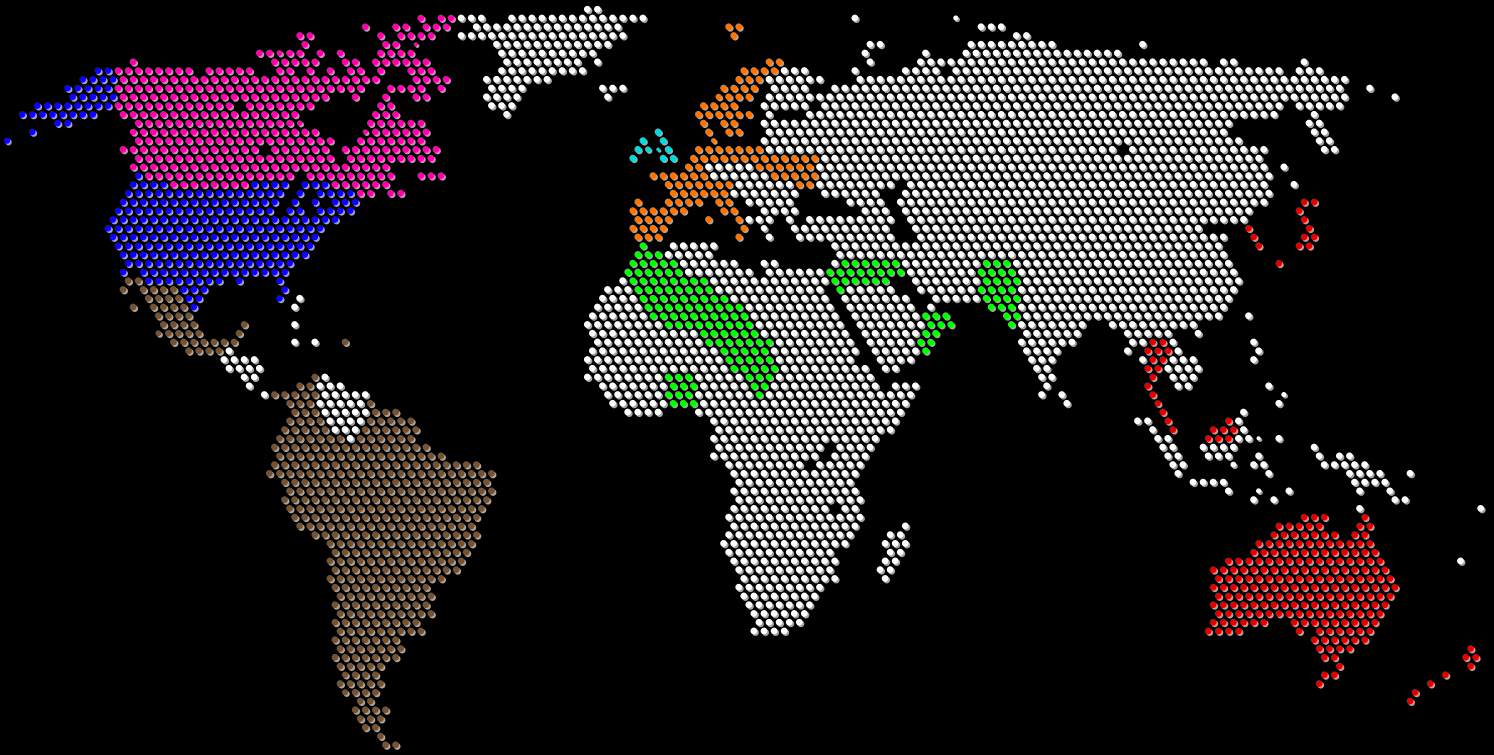

WILCOX INDUSTRIES CORP. ONE WILCOX WAY NEWINGTON, NH 03801 USA

PHONE: 603.431.1331 FAX: 603.431.1221

[WWW.WILCOXIND.COM](http://WWW.WILCOXIND.COM)



©2024 Wilcox Industries Corp. All rights reserved. Printed in USA. U.S. and foreign patents pending. The WILCOX logo, "X" icon, Hybrid PATRIOT 5510, ERGOCTO and AERONOX are Federally Registered Trademarks of Wilcox Industries Corp. BTAC is a registered trademark of Blueforce Development Corp. Wilcox RAID Xe, RAPSTAR Xe, FUSION SYSTEM, FUSION ARX160, FUSION KMA556, FUSION G62, BOSS Xe, MRF Xe, RAAM GSS, ERGOCTO, DPAM, SKULL LOCK, HELLBOY, Xe, "Modular By Design" and "Our Customer's Life Depends On It" are all trademarks of Wilcox Industries Corp. Specifications subject to change without notice. All other Trademarks and Registered Trademarks are properties of their respective companies. This brochure does not constitute an offer or commitment to sell. | Technical Data regulated and restricted by the EAR, U.S. Department of Commerce license may be required for export or re-export. | Export of certain products are regulated by the U.S. Department of State and U.S. Department of Commerce in accordance with guidelines of ITAR per Title 22, Code of Federal Regulations, Parts 121-128. | U.S. Food and Drug Administration restricts the sale of high powered lasers to military and law enforcement agencies only.